



DANICO BRASS LIMITED
31 – 35 Winchester Road
Swiss Cottage
London NW3 3NR

Tel: 020 7483 4477

Fax: 020 7722 7992

e-mail: sales@danico.co.uk

www.danico.co.uk

The
DANICO

*Catalogue of
Architectural Ironmongery*

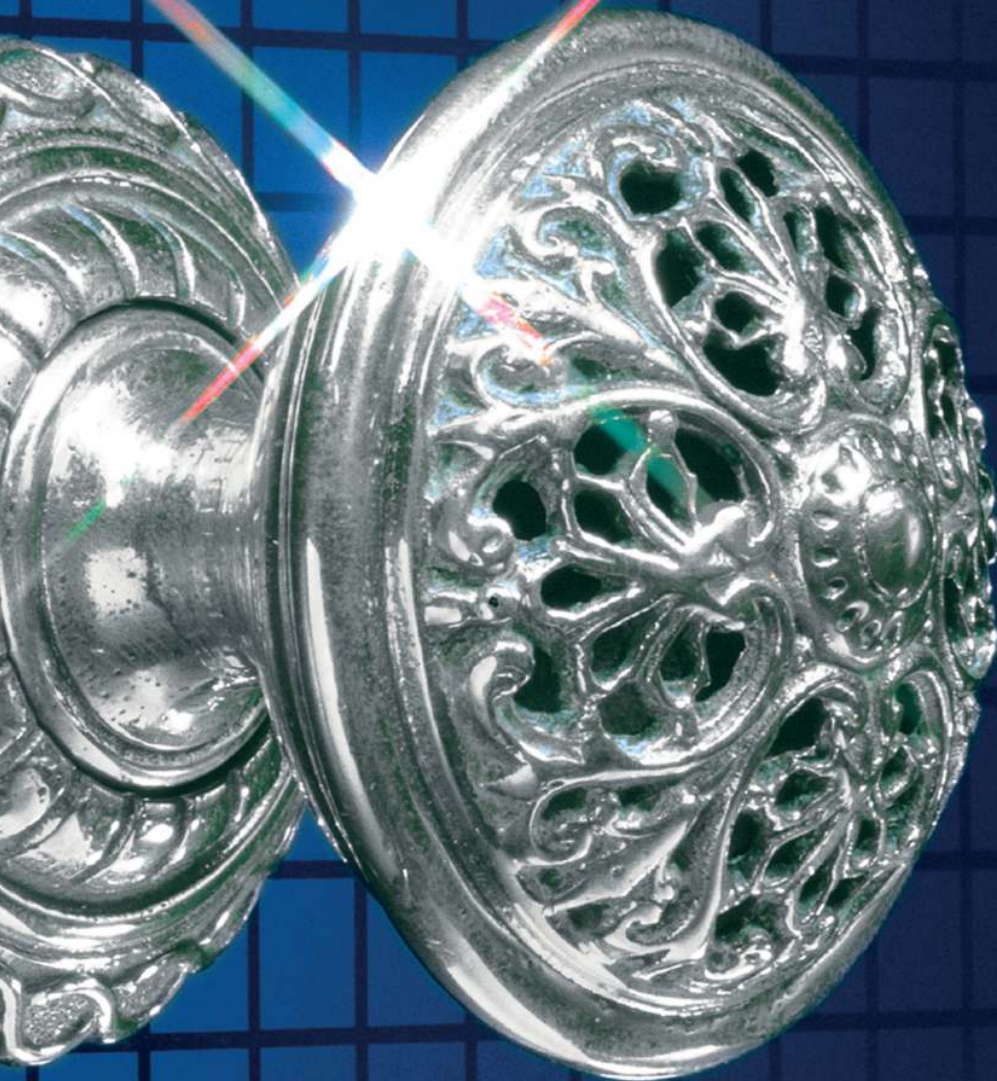

**FIFTH
EDITION**

Welcome to the Danico Catalogue of Architectural Ironmongery



We are an independent family-owned company established in 1979 with over three generations of experience in the Architectural Ironmongery and Hardware Trade. Our showroom and head

office is based in Swiss Cottage, North London. We are able to advise and supply a complete range of Architectural Ironmongery sourced from all over the world, to offer you the widest possible choice of high quality, value for money, products.

Our clients include discerning home-owners, architects, builders, interior designers, hotels and corporations who are building new properties or refurbishing existing homes. We can supply any product anywhere in the world.

In this 100 page catalogue it has only been possible to show the majority of our standard range of products. Other items, sizes and finishes, are available to order. We also have the facilities to manufacture "special" items, made to client's specifications and designs.

Our catalogue has been colour-coded in separate sections, and a key to the abbreviated finish codes is shown on the contents page opposite.

On the last two pages we show a small selection of Decorative Grilles, Electrical Accessories, Jado Taps and Bathroom Accessories. Separate information is available on request.

Our experienced and friendly staff will be delighted to welcome you to our showroom or to help and advise you on the telephone.

We hope you find our catalogue informative and easy to use.



First published 1996.

Second edition 1998.

Third edition 2001.

Fourth Edition 2005.

Fifth Edition 2007.

All rights reserved. No part of this publication may be reproduced, stored in a retrieval system, or transmitted in any form or by any means, mechanical or otherwise, without prior permission in writing of the copyright owners.

**Published by
Danico Brass Limited.**

**Printed by
Universal Media Services Ltd**

All products are offered for sale only under the terms of our Standard Conditions of Sale. Danico pursues a policy of constantly updating and reviewing the product range and the company reserves the right to alter specification or availability without notice.



**Rahul, Rishi, Annelise
and Ashok Daryanani**

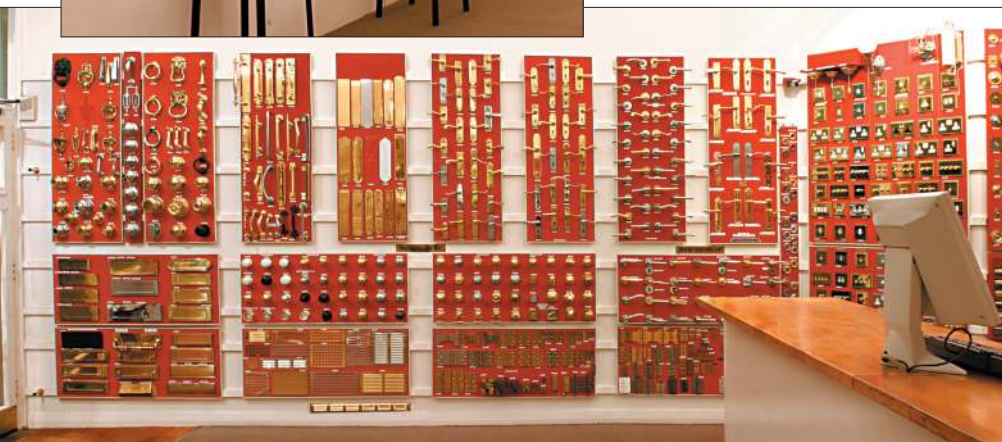

**DANICO BRASS
LIMITED
31 – 35 Winchester Road
Swiss Cottage
London NW3 3NR**

**Tel: 020 7483 4477
Fax: 020 7722 7992
e-mail: sales@danico.co.uk
www.danico.co.uk**

FIFTH EDITION

C O N T E N T S



ENTRANCE DOOR HARDWARE

CENTRE DOOR KNOBS 2-3 LETTER PLATES 4-6 BELL PUSHES 7 DOOR KNOCKERS 8-9
PULL HANDLES 10-11 DOOR CLOSERS 12 PANIC HARDWARE 13 NUMERALS & SIGNS 14

PAGE 2 – 14



CUPBOARD KNOBS & HANDLES

CUPBOARD KNOBS 16-20, 22, 23, 25-26 CUPBOARD HANDLES 19, 22-26 DROP HANDLES 21
FLUSH HANDLES 27 ESCUTCHEONS 28

PAGE 15 – 28



CABINET HARDWARE

CABINET CATCHES 30 CABINET HARDWARE 30-31 HANDRAIL BRACKETS 32
SHELF BRACKETS 32-33 METAL PROFILES 34-35 TUBE FITTINGS 36-38 CURTAIN RAIL FITTINGS 38

PAGE 29– 38



IRONMONGERY

WINDOW FITTINGS 40-46 DOOR STOPS 47 HOOKS 48-49 HINGES 50-53
BOLTS 54-57 VENTS 58

PAGE 39 – 58



DOOR FURNITURE

LEVER HANDLES 60-75 JADO LEVER HANDLES 76-77 ESCUTCHEONS 78-79
TURN & RELEASES 80-81 KNOB FURNITURE 82-87 RING HANDLES 84 FINGER PLATES 88

PAGE 59 – 88



LOCKS

CABINET LOCKS 90 WINDOW LOCKS 91 MORTISE LATCHES 92
MORTISE LOCKS 93-96 RIM LOCKS 97 NIGHT LATCHES 98-99

PAGE 89 – 99

ADDITIONAL PRODUCTS

DECORATIVE GRILLES 100 JADO BATHROOM ACCESSORIES AND TAPS 100
ELECTRICAL ACCESSORIES 101

PAGE 100 – 101

FINISH CODES

FINISH	DESCRIPTION	FINISH	DESCRIPTION
ANT	Antique Iron	NK/GO	Nickel & Gold
ANTBR	Antique Brass	NP	Nickel Plated
B/LUX	Brilliant Brass Plated	PATIN	Patine Steel
BB	Barrelled Brass/Burnished Brass	PB	Polished Brass
BJP	Black Japaned on Iron or Steel	PB/BK	Polished Brass & Black
BK/CL	Black & Clear	PB/CL	Polished Brass & Clear
BLKNK	Black Nickel	PB/CP	Polished Brass & Chrome
BLACK	Black China/Nylon/Rubber	PB/MN	Polished Brass & Matt Nickel
BRW	Brown	PB/NK	Polished Brass & Nickel Plated
BROWN	Brown	PB/SM	Polished Brass & Black Nickel (Smoke)
BRZ	Bronze On Steel	PB/SB	Polished Brass & Satin Brass
BZP	Bright Zinc Plated	PB/SS	Polished Brass & Stainless Steel
CLEAR	Clear Glass or Acrylic	PB/UL	Polished Brass Un-Lacquered
CP	Polished Chrome	PB/WH	Polished Brass & White
CP/CL	Chrome & Clear	PSS	Polished Stainless Steel
CP/GO	Chrome & Gold	PVD	Physical Vapour Deposit (Non Tarnish Brass)
CP/GY	Chrome & Grey	RBMA	Real Bronze Metal Antique
CP/SM	Chrome & Black-Nickel (Smoke)	S/COL	Self Colour
CP/SS	Chrome & Stainless Steel	SAA	Satin Anodised Aluminium
CP/WH	Chrome & White	SAB	Satin/Sanded Brass
EBP	Electro Brass Plated on Steel/Zinc	SCP	Satin Chrome Plated
GAA	Gold Anodised Aluminium	SE	Silver Enamel
GOLD	Gold Plated	SNP	Satin Nickel Plated
GREY	Grey Enamel	SSS	Satin Stainless Steel
GY/WH	Grey & White	SS/PS	Satin Stainless/Polished Stainless Steel
IBMA	Imitation Bronze Metal Antique	WH	White
MC/CP	Matt Chrome & Polished Chrome	WH/BU	White & Blue
MNK	Matt Nickel	WHITE	White China/Nylon/Enamelled
MN/CP	Matt Nickel & Polished Chrome	WH/GO	White & Gold

All measurements are metric, except where it is appropriate to retain traditional imperial sizes



CENTRE DOOR KNOBS

Large fixed pull Knobs suitable for entrance doors. Bolt fixed through door thickness. Cannot be removed from outside. Sizes are approximate.

K= Knob R=Rose

10.140.10	K75 R90mm	PB
10.140.20	K75 R90mm	CP
10.140.21	K75 R90mm	SCP
10.150.10	K75 R80mm	PB
10.150.20	K75 R80mm	CP
10.150.21	K75 R80mm	SCP
10.160.10	K65 R80mm	PB
10.160.20	K65 R80mm	CP
10.160.21	K65 R80mm	SCP
10.215.10	K60 R62mm, K63 R73mm	PB
10.220.10	K72 R76mm	PB
10.220.20	K72 R76mm	CP
10.220.21	K72 R76mm	SCP
10.220.41	K72 R76mm	MNK
10.220.53	K72 R76mm	IBMA
10.220.82	K65 R75mm, Iron	BJP
10.248.21	K84 R82mm	SCP

CARE INSTRUCTIONS

All Danico Polished Brass products are protected by the most advanced lacquer available and under normal circumstances should give many years of service. We recommend occasional cleaning with a cloth moistened with soapy water. After cleaning apply a thin coat of good wax polish.

UNDER NO CIRCUMSTANCES USE ANY METAL POLISHES OR ABRASIVE CLEANERS.

It should be noted that the life of a lacquer coating is limited and will eventually break down. Adverse conditions (industrial pollution, sea air, acid rain, etc) or repeated continual handling may cause the coating to deteriorate prematurely. Should this occur, any trace of lacquer can be removed by the application of a paint stripper, or acetone (used according to the makers instructions), the item will then be unlacquered and in a suitable condition for cleaning with a metal polish.



10.140.21



10.140.10



10.215.10
(62mm)



10.248.21

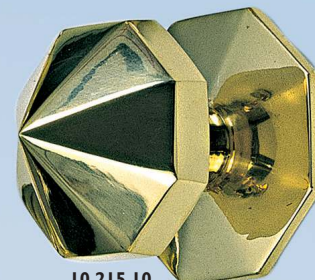

10.215.10
(73mm)



10.160.21



10.160.20



10.160.10



10.150.10



10.220.82

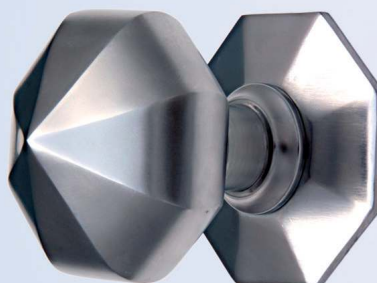

10.220.21



10.220.10

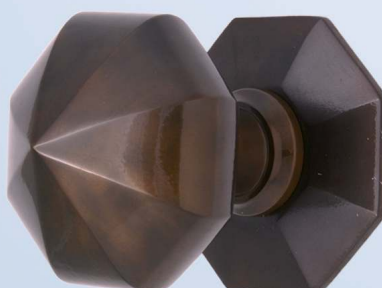

10.220.53

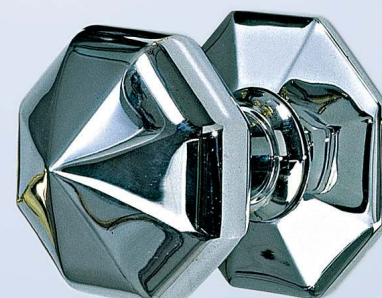

10.220.20

DANICO

020 7483 4477

CENTRE DOOR KNOBS

Large fixed pull Knobs suitable for entrance doors. Bolt fixed through door thickness. Cannot be removed from outside. Sizes are approximate.



	K= Knob	R=Rose	
10.255.10	K99	R108mm	PB
10.255.20	K99	R108mm	CP
10.255.21	K99	R108mm	SCP
10.300.10	K67	R80mm,	
	K81	R87mm,	
	K91	R97mm	PB
10.370.10	K100	R130mm	PB
10.420.10	K60	R64mm,	
	K67	R80mm	PB
10.420.20	K60	R64mm,	
	K67	R80mm	CP
10.420.82	K70	R79mm, Iron	BJP
10.425.10	K70	R105mm	PB
10.425.20	K70	R105mm	CP
10.425.21	K70	R105mm	SCP
10.440.10	K80	R86mm,	
	K101	R105mm	PB
10.440.20	K80	R86mm,	
	K101	R105mm	CP
10.440.21	K80	R86mm,	
	K101	R105mm	SCP
10.490.10	K78	R83mm	PB
10.900.10	K78	R83mm,	
	K98	R109mm	PB

LETTERPLATES

Approximate external sizes.

CARE INSTRUCTIONS
See page 2

CAST BRASS

11.100.10	8x3", 10x3", 10x3 1/2", 10x4", 12x4", 13x3" 14x5", 16x5"	PB
11.100.20	8x3", 10x3", 10x3 1/2", 10x4", 12x4", 14x5", 16x5"	CP
11.100.21	10x3", 10x3 1/2", 10x4", 12x4", 14x5", 16x5"	SCP
11.100.53	12x4"	IBMA

DIE-CAST BRASS

11.110.10	10x3", 10x4", 11x3 1/2", 12x4", 14x4 1/2"	PB
11.110.20	10x3", 10x4", 11x3 1/2", 12x4", 14x4 1/2"	CP
11.110.21	10x3", 10x4", 11x3 1/2", 12x4", 14x4 1/2"	SCP

BLACK IRON

11.120.82	8x3", 10 3/8x3 1/4", 10 1/2x4 1/2", 14x4"	BJP
-----------	--	-----

Vertical Letter Plate

11.210.10	9x2 1/2"	PB
-----------	----------	----

ALSO
CP &
SCP

11.100.10
(12x4")

11.100.10
(8x3")

ALSO
CP &
SCP

11.100.10
(14x5")

11.120.82
(10 1/2x4 1/2")

11.110.10
(11x3 1/2")

11.110.10
(10x4")

11.110.10
(10x3")

11.210.10
(9x2 1/2")

11.110.10
(12x4")

11.110.20
(12x4")

11.110.21
(12x4")

LETTERPLATES

Approximate external sizes.

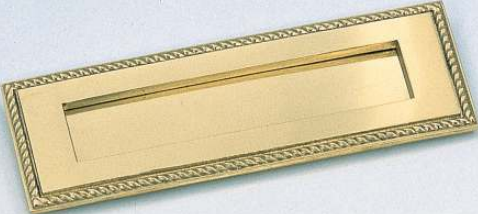

11.130.10
(11x3 1/2")

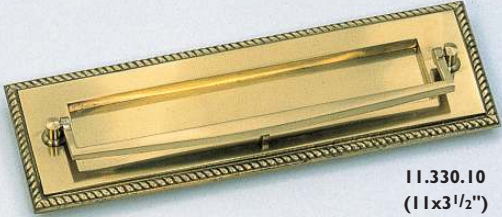

11.330.10
(11x3 1/2")



ALSO
CP &
SCP

11.135.10



11.149.10



11.190.10



ALSO
CP &
SCP

11.370.10



ALSO
CP

11.300.10



11.280.10

LETTER PLATES

11.130.10	Georgian Rope Edge	10x3", 11x3 1/2"	PB
11.135.10	Plain Step Edge	310x87mm	PB
11.135.20		310x87mm	CP
11.135.21		310x87mm	SCP
11.149.10	Constable	305x85mm	PB
11.190.10	Princess	305x85mm	PB
11.280.10	Shaped	280x75mm	PB

POSTAL KNOCKERS

11.300.10	10x3"	PB
11.300.20	10x3"	CP
11.330.10	10x3", 11x3 1/2"	PB

LETTER PLATES

11.370.10	Artdeco	255x90mm	PB
11.370.20	Artdeco	255x90mm	CP
11.370.21	Artdeco	255x90mm	SCP

LETTERPLATES

Approximate external sizes.

CARE INSTRUCTIONS

See page 2

POSTAL KNOCKER

11.310.10	12x4"	PB
11.320.82	203x89, 300x105mm	BJP

POSTAL HANDLES

11.345.10	Cast 10x4", 12x4"	PB
11.345.20	Cast 10x4", 12x4"	CP
11.345.21	Cast 10x4", 12x4"	SCP
11.372.10	Artdeco 255x90mm	PB
11.372.20	Artdeco 255x90mm	CP
11.372.21	Artdeco 255x90mm	SCP

LETTER TIDY WITH SIDE BRACKETS

11.700.10	95x280mm, 95x305mm, 127x356mm, 127x406mm	PB
11.700.20	95x280mm, 95x305mm, 127x356mm, 127x406mm	CP
11.700.21	95x280mm, 95x305mm, 127x356mm, 127x406mm	SCP
11.710.10	Vertical 3x12"	PB
11.710.50	Vertical 3x12"	PSS
11.710.51	Vertical 3x12"	SSS

LETTER HOOD

11.750.10	10", 12"	PB
11.750.50	10", 12" Stainless Steel	PSS
11.750.51	10", 12" Stainless Steel	SSS

LETTER CAGES

11.800.20	2x9x5", 14x10x6" 18x14x8" Steel	CP
11.800.60	12x9x5", 14x10x6" 18x14x8" Steel	White
11.810.80	12x9x5", 14x10x6", 18x14x8" Steel	EBP



11.310.10



11.320.82



ALSO
CP &
SCP

11.345.10
(12x4")



ALSO
CP &
SCP

11.372.10



ALSO
SSS &
PSS

11.750.10



ALSO
CP

11.700.10



11.700.21

ALSO
CP



11.810.80



ALSO
SSS &
PSS

11.710.10

BELL PUSHES

Bell pushes require a hole to be drilled, approximately 25mm deep x 22mm diameter, to accept the bell push contact, except items marked ★, which are surface mounted.

Suitable for low voltage only.



15.180.82

15.900.10

15.120.10

15.120.21

15.222.20

15.222.10



15.444.10

15.444.20

15.425.10

15.425.21



15.570.10



15.570.20



15.200.10



15.200.21



15.520.10



15.530.10



15.300.10



15.510.10



15.510.20



15.510.21



15.225.20
(65mm)



15.225.10
(65mm)



15.228.10
(100mm)



15.228.10
(150mm)



15.228.10
(75mm)



15.185.82

15.120.10	60mm	PB
15.120.20	60mm	CP
15.120.21	60mm	SCP
15.180.82	125x30mm, Iron	BJP
15.185.82	60mm, Iron	BJP
15.200.10	75x25mm	PB
15.200.20	75x25mm	CP
15.200.21	75x25mm	SCP
★ 15.222.10	Surface, 75x31mm	PB
★ 15.222.20	Surface, 75x31mm	CP
15.225.10	65mm	PB
15.225.20	65mm	CP
15.228.10	Engraved with ceramic push "PRESS"	
	75, 100, 150mm	PB
15.300.10	75x30mm	PB
15.425.10	68mm	PB
15.425.20	68mm	CP
15.425.21	68mm	SCP
15.444.10	60mm	PB
15.444.20	60mm	CP
15.444.21	60mm	SCP
15.510.10	85x32mm	PB
15.510.20	85x32mm	CP
15.510.21	85x32mm	SCP
15.520.10	85x32mm	PB
15.530.10	85x32mm	PB
15.570.10	88x88mm	PB
15.570.20	88x88mm	CP
15.900.10	90mm Princess	PB

For Bell Pushes operating on 220V please see our Electrical Catalogue.

DOOR KNOCKERS

Bolt fixed through door thickness. Cannot be removed from outside.

CARE INSTRUCTIONS
See page 2

12.100.10	140mm	PB
12.100.20	140mm	CP
12.100.21	140mm	SCP
12.100.41	140mm	MNK
12.100.53	140mm	IBMA
12.110.10	180mm	PB
12.110.20	180mm	CP
12.110.21	180mm	SCP
12.140.10	190mm	PB
12.140.20	190mm	CP
12.140.21	190mm	SCP
12.200.10	140mm	PB
12.200.20	140mm	CP
12.200.21	140mm	SCP
12.210.10	160mm	PB
12.210.20	160mm	CP
12.210.21	160mm	SCP
12.220.10	150mm	PB
12.220.20	150mm	CP
12.220.21	150mm	SCP
12.240.10	160, 190mm	PB
12.280.10	165mm	PB
12.280.20	165mm	CP
12.280.21	165mm	SCP



12.100.10



12.240.10
(160mm)



12.100.20

ALSO
SCP



12.200.10

ALSO
CP &
SCP



12.280.10

ALSO
CP &
SCP

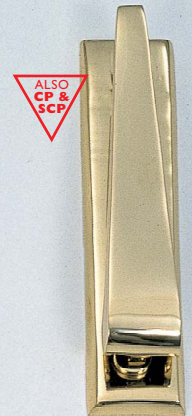

12.210.10

ALSO
CP &
SCP



12.140.20

ALSO
SCP



12.140.10

12.110.20

12.110.10



12.110.21



12.220.10

ALSO
CP



12.220.21

DOOR KNOCKERS



12.430.82



12.7169.82

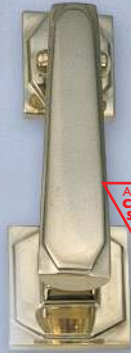

12.425.10

ALSO
CP &
SCP



12.420.10



12.450.10



12.400.10



12.900.10



12.320.10



12.490.10



12.330.10



12.495.10



12.910.10



12.300.10
(200mm)



12.455.10



12.495.10

Bolt fixed through door thickness. Cannot be removed from outside.

12.300.10	170, 200mm	PB
12.320.10	165mm	PB
12.330.10	190mm	PB
12.400.10	180mm	PB
12.420.10	190mm	PB
12.425.10	155mm	PB
12.425.20	155mm	CP
12.425.21	155mm	SCP
12.430.82	190mm, Iron	BJP
12.450.10	250mm	PB
12.455.10	225mm	PB
12.490.10	105mm	PB
12.495.10	152mm	PB
12.7169.82	125mm, Iron	BJP
12.900.10	105mm	PB
12.910.10	150mm	PB

PULL HANDLES

Approximate overall sizes.

CARE INSTRUCTIONS

See page 2

PULL HANDLE

16.180.10	150mm	PB
16.180.20	150mm	CP
16.180.21	150mm	SCP
16.200.55	150, 225, 300mm	
	C-T-C, Alum	SAA
16.220.50	150, 225, 300, 600mm	
	C-T-C, S/Steel	PSS
16.220.51	150, 225, 300, 600mm	
	C-T-C, S/Steel	SSS
16.222.50	150, 225, 300, 600mm	
	C-T-C, Back to Back	PSS
16.222.51	150, 225, 300, 600mm	
	C-T-C, Back to Back	SSS
16.2319.51	19mm diameter bar	
	225,300mm C-T-C	SSS
16.2325.51	25mm diameter bar	
	225,300mm C-T-C	SSS
16.240.10	225, 300mm Brass	PB
16.240.20	225, 300mm Brass	CP
16.370.10	245, 290mm	PB
16.370.20	245, 290mm	CP
16.370.21	245, 290mm	SCP

PULL ON PLATE

16.372.10	305, 356mm	PB
16.372.20	305, 356mm	CP
16.372.21	305, 356mm	SCP

PULL HANDLE

16.400.10	225, 305mm	PB
16.400.20	225, 305mm	CP
16.400.21	225, 305mm	SCP
16.400.55	225mm Alum	SAA

PULL HANDLE

16.800.10	174mm C-T-C	PB
16.800.20	174mm C-T-C	CP
16.800.21	174mm C-T-C	SCP
16.800.28	174mm C-T-C	PB/CP

BACK-TO-BACK FIXING

16.802.10	174mm C-T-C	PB
16.802.20	174mm C-T-C	CP
16.802.21	174mm C-T-C	SCP
16.802.28	174mm C-T-C	PB/CP



PULL HANDLES

Approximate overall size.



16.780.10 (LH)



16.770.10
(380mm)



16.700.10
(305mm)



16.495.10



16.490.10



16.950.10



16.940.10



16.910.10



16.900.10



16.310.10
(190mm)



16.300.10

PULL HANDLE		
16.300.10	225mm	PB
16.310.10	190, 225mm	PB
16.490.10	240mm	PB

PULL ON PLATE		
16.495.10	300mm	PB
16.700.10	305, 380mm	PB
16.770.10	305, 380mm	PB
16.780.10	450mm, LH or RH	PB

PULL HANDLE		
16.900.10	178mm	PB

PULL ON PLATE		
16.910.10	229mm	PB

PULL HANDLE		
16.940.10	265mm	PB

PULL ON PLATE		
16.950.10	265mm	PB

DOOR CLOSERS

18.0100.10	Perko	PB
18.0120.10	Perko, Extended Link	PB
18.0140.40	Standard	NP
18.0140.80	Standard	EPB
18.0200.20	Gibraltar Closer	CP
18.0200.21	Gibraltar Closer	SCP
18.0200.60	Gibraltar Closer	WHITE
18.0200.80	Gibraltar Closer	EBP
18.0500.10	Perkomatic Hydraulic Closer	PB
18.2003.10	Universal, Size 3	PB
18.2003.20	Universal, Size 3	CP
18.2003.85	Universal, Size 3	SE
18.2004.10	Universal, Size 4	PB
18.2004.85	Universal, Size 4	SE
18.2005.10	Universal, Size 5	PB
18.2005.85	Universal, Size 5	SE
18.3000.10	Door Selector	PB
18.3000.21	Door Selector	SCP
18.3000.85	Door Selector	SE
18.3800.19	Door Selector	BLUX
18.3800.20	Door Selector	CP
18.3800.51	Door Selector	SSS

PIVOT DOOR FITTINGS

18.3510.85	Top Centre (2 Parts)	SE
18.3515.50	Top Centre Cover Plate	PSS
18.3550.85	Door Strap	SE
18.3580.85	Ball-Bearing Pivot	SE

18.4622.85	Concealed Closer	
	LH or RH Size 2	SE
18.4623.85	(As above) Size 3	SE

BRITON FLOOR SPRING MECHANISMS & BOX		
18.7002.00	Size 2	S/COL
18.7003.00	Size 3	S/COL
18.7004.00	Size 4	S/COL
18.7053.10	Cover Plate	PB
18.7053.50	Cover Plate	PSS
18.7053.51	Cover Plate	SSS
18.7060.10	Double-Action Top Centre (2 Parts)	PB
18.7060.21	(as above)	SCP
* 18.7066.10	Single-Action Top Centre, LH or RH	PB
* 18.7066.21	(as above)	SCP
18.7080.85	Double-Action Strap	SE
* 18.7086.85	Single-Action Strap, LH or RH	SE

* Not Illustrated

DANICO
020 7483 4477

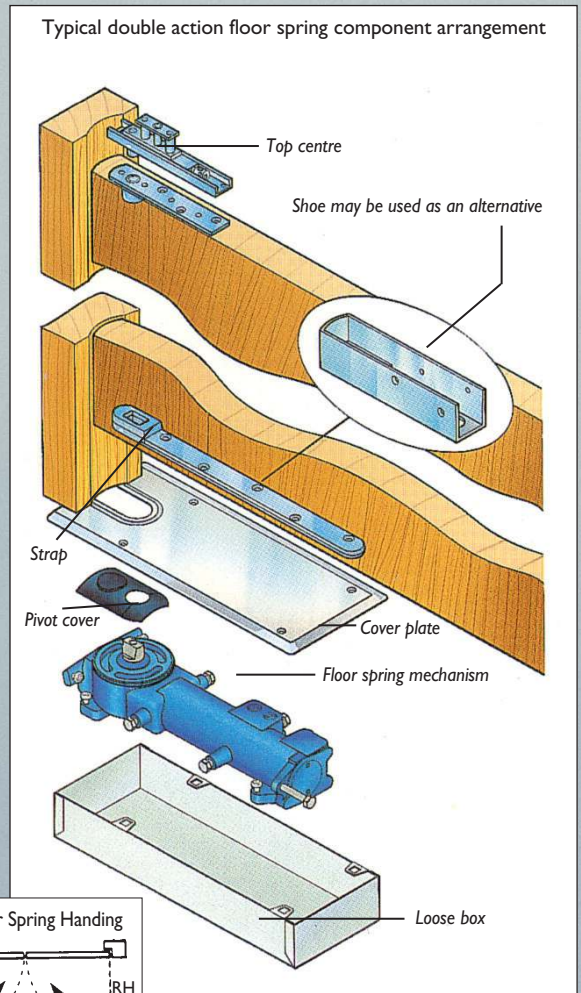
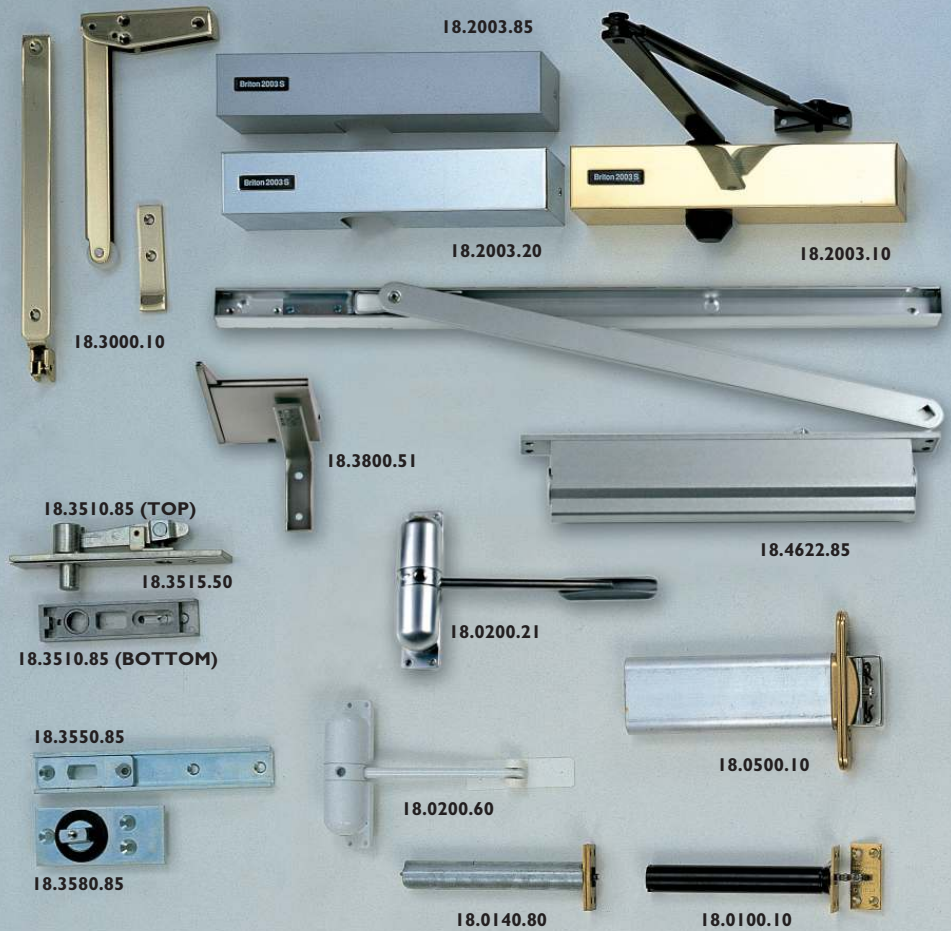

EMERGENCY EXIT HARDWARE

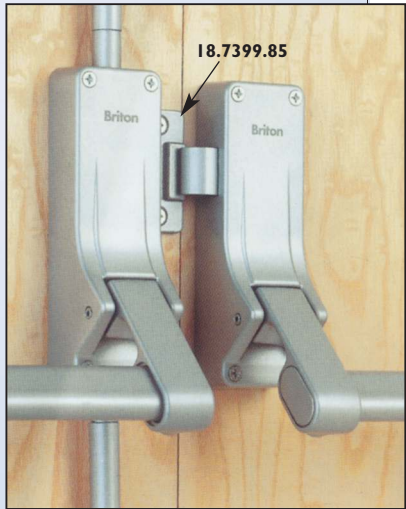

Emergency Exit Hardware is designed to provide a means of escape at all times by the simple act of pushing a bar fitted across the full width of the door or depressing a pad attached to the operating body. Access from the outside is restricted for security purposes, but may be obtained by the addition of a lock attachment, which in no way interferes with escape, even when locked.

18.7372.85	Push Panic Bolt	SE
18.7376.85	Single Panic Bolt	SE
18.7378.85	Panic Latch, LH or RH	SE
18.7379.85	Panic Bar & Mortise Night Latch	SE
18.7389.85	Panic Pad & Mortise Night Latch	SE
18.7399.85	Strikeplate only for Double Doors	SE
18.7412.85	Outside access Lever for Panic Bolt	SE
18.7413.85	Outside access Knob for Panic Bolt	SE
18.7438.85	Push Pad Panic Latch LH or RH	SE

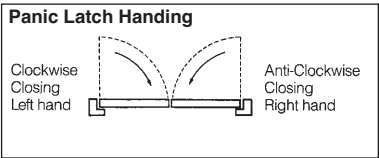

NUMERALS & SIGNS

All numerals and alphabets have rear pin fixings. Pin holes should be PRE-DRILLED. Protect the face of each character with a wooden block during installation.

NUMERALS

14.1002.10	Cast, 50mm	PB
14.1003.10	Cast, 75mm	PB
14.1004.10	Cast, 100mm	PB
14.1006.10	Cast, 150mm	PB
14.1202.10	Die-Cast, 50mm	PB
14.1364.51	St-Steel, 100mm	SSS
14.1366.51	St-Steel, 150mm	SSS
14.1403.10	Forged, 75mm	PB
14.1403.20	Forged, 75mm	CP
14.1403.21	Forged, 75mm	SCP
14.1952.82	Iron, 50mm	BJP
14.1954.82	Iron, 100mm	BJP
14.1956.82	Iron, 150mm	BJP

ALPHABETS

14.2002.10	Cast, 50mm	PB
14.2202.10	Die-Cast, 50mm	PB
14.2202.20	A,B,C only, 50mm	CP
14.2202.21	A,B,C only, 50mm	SCP
14.2363.51	a,b,c,d, only, 80mm	SSS
14.2364.51	a,b,c,d, only, 110mm	SSS

BRASS SIGNS

14.500.10	LADIES, 6x2"	PB
14.505.10	GENTLEMEN, 8x2"	PB
14.515.10	TOILET, 6x2"	PB
14.520.10	PRIVATE, 6x2"	PB
14.530.10	PULL, 3x1 3/8"	PB
14.535.10	PUSH, 3x1 3/8"	PB
14.580.10	Male or Female Symbol	Engraved, 6x4" PB

BRASS AND S/STEEL ROUND SIGNS 75MM

14.680.10	Female 75mm	PB
14.680.51	Female 75mm	SSS
14.682.10	Male 75mm	PB
14.682.51	Male 75mm	SSS
14.683.10	Male&Female 75mm	PB
14.683.51	Male&Female 75mm	SSS
14.685.10	Disabled 75mm	PB
14.685.51	Disabled 75mm	SSS
14.690.10	Fire Door Keep Shut	PB
14.690.51	Fire Door Keep Shut	SSS
14.692.10	Fire Door Keep Locked	PB
14.692.51	Fire Door Keep Locked	SSS

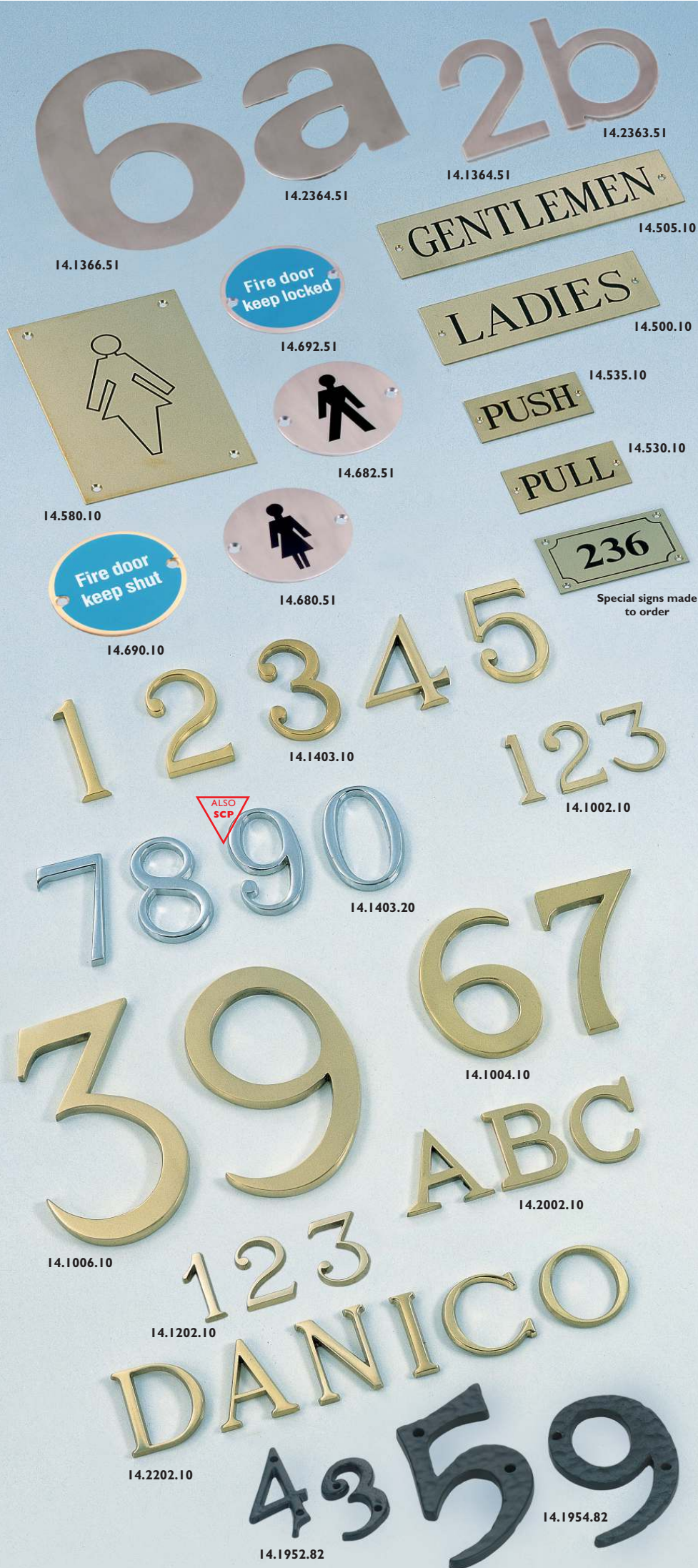

**CUPBOARD KNOBS
& HANDLES**

CUPBOARD KNOBS



CUPBOARD HANDLES



DROP HANDLES



FLUSH HANDLES



ESCUTCHEONS

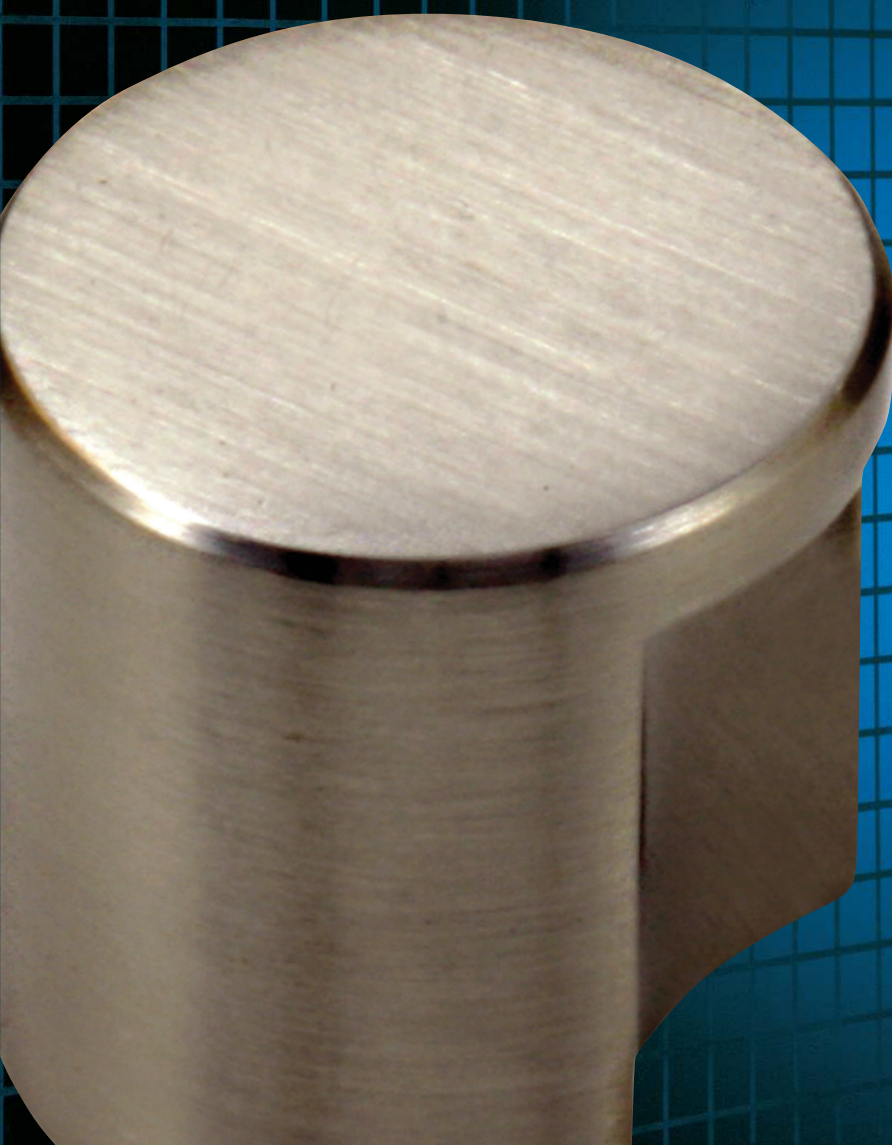

CUPBOARD KNOBS

ROSETTES ONLY

20.000.10	25, 30, 35, 40mm	PB
20.000.20	18, 25, 30, 35mm	CP

PORCELAIN CUPBOARD KNOBS

20.100.60	32, 38, 50mm	WHITE
20.100.69	32, 38mm	WH/GO
20.101.60	30, 40mm	WHITE
20.101.62	30, 40mm	BLACK
20.102.60	32, 35, 38mm	WHITE
20.103.60	with Brass Collar	
	32, 35, 38mm	WHITE

ACRYLIC CUPBOARD KNOBS

20.110.05	25, 32, 38mm	CLEAR
20.111.05	25, 32, 38mm	CLEAR

GLASS CUPBOARD KNOBS

20.115.15	32, 40mm	PB/CL
20.115.25	32, 40mm	CP/CL
20.119.15	25, 30, 35mm	PB/CL
20.119.21	25, 30, 35mm	SC/CL
20.119.25	25, 30, 35mm	CP/CL
20.120.15	Crystal Cut	
	32mm	PB/CL
20.221.15	25, 32, 38mm,	PB/CL
20.221.25	25, 32, 38mm,	CP/CL

20.3280.20	18mm,	White +CP
20.3350.10	32mm,	White +PB
20.3355.41	32mm,	Black + MNK
20.3376.20	25mm,	Frost + CP
20.3376.41	25mm,	Frost + MNK

FOR FURTHER INFORMATION
ON FINISH DETAILS SEE PAGE I



CUPBOARD KNOBS



ACRYLIC CUPBOARD KNOBS

20.114.15	18, 25, 35mm	PB/CL
20.114.25	18, 25, 35mm	CP/CL

CRYSTAL CUPBOARD KNOBS

20.116.15	20, 30, 40mm	PB/CL
20.116.25	20, 30, 40mm	CP/CL

BRASS KNOBS

20.125.10	25, 32mm	PB
20.125.20	25, 32mm	CP
20.125.41	25, 32mm	MNK
20.128.10	12mm	PB
20.128.20	12mm	CP
20.128.41	12mm	MNK
20.129.10	12mm on 17mm Rose	PB
20.129.20	12mm on 17mm Rose	CP
20.129.41	12mm on 17mm Rose	MNK
20.130.41	16mm	MNK
20.133.20	12mm	CP
20.152.10	25, 32, 38mm	PB
20.160.10	40mm	PB
20.160.20	40mm	CP
20.166.10	25, 32, 38mm	PB
20.175.10	20, 25, 32mm	PB
20.175.20	20, 25, 32mm	CP
20.175.41	20, 25, 32mm	MNK
20.175.51	20, 25, 32mm	SSS
20.181.10	30, 40mm	PB
20.183.10	25, 32mm	PB
20.240.03	25, 32, 38mm	ANTBR
20.240.10	25, 32, 38mm	PB
20.245.10	20, 25, 32, 38mm	PB
20.266.03	25, 32mm	ANTBR
20.266.10	12mm	PB
20.352.10	17mm	PB
20.352.20	17mm	CP
20.352.41	17mm	MNK
20.362.20	15mm	CP
20.362.21	15mm	SCP
20.362.41	15mm	MNK
20.8323.10	12mm	PB

RING HANDLE

21.152.10	40, 50mm	PB
-----------	----------	----

CUPBOARD KNOBS

CUPBOARD KNOBS

20.238.20	25, 30, 35mm	CP
20.248.10	25, 32, 38mm	PB
20.248.20	25, 32, 38mm	CP
20.248.21	25, 32, 38mm	SCP
20.248.41	25, 32, 38mm	MNK
20.250.10	25, 32, 38, 42, 50mm	PB
20.262.03	16mm	ANTBR
20.262.10	9, 11, 12, 16, 22mm	PB
20.262.20	19mm	CP
20.262.40	19mm	NP
20.265.03	25mm	ANTBR
20.265.10	25, 32mm	PB
20.267.10	12, 15, 22, 30mm	PB
20.270.10	25, 32, 38mm	PB
20.272.10	30, 40mm	PB
20.272.20	30, 40mm	CP
20.288.10	12, 20, 25mm	PB
20.3058.20	28mm	CP
20.3058.41	28mm	MNK
20.3060.20	24, 28mm	CP
20.3060.41	24, 28mm	MNK
20.3090.21	28mm	SCP
20.3090.41	24, 28mm	MNK
20.341.20	24, 28mm	CP
20.341.21	24, 28mm	SCP
20.346.10	26mm	PB
20.346.20	26mm	CP
20.346.41	26mm	MNK
20.347.20	25, 30mm	CP
20.347.41	25, 30mm	MNK
20.360.20	18mm	CP
20.360.41	18mm	MNK
20.364.41	18mm	MNK
20.382.10	22mm	PB
20.382.20	22mm	CP
20.382.21	22mm	SCP
20.385.20	20mm	CP
20.385.41	20mm	MNK
20.425.10	32, 38mm	PB
20.425.20	32, 38mm	CP
20.569.41	18x28mm	MNK
20.572.41	13 x 22, 14 x 32mm	MNK
20.575.10	22x50mm	PB
20.575.20	22x50mm	CP
20.575.21	22x50mm	SCP
20.576.10	22x50x40mm	PB
20.576.20	22x50x40mm	CP
20.576.21	22x50x40mm	SCP
20.8322.20	Thumb Pull 23mm	CP
20.8322.21	Thumb Pull 23mm	SCP
20.8322.41	Thumb Pull 23mm	MNK
20.8910.20	29mm	CP
20.8910.21	29mm	SCP
20.8914.20	24, 29mm	CP
20.8914.41	24, 29mm	MNK
20.8920.22	30mm	MC/CP
20.8925.20	25mm	CP
20.8925.41	25mm	MNK



CUPBOARD KNOBS/HANDLES

CUPBOARD KNOBS

20.148.20	32mm	CP
20.148.41	32mm	MNK
20.149.20	21mm	CP
20.149.41	21mm	MNK
20.3333.20	32mm	CP
20.3365.41	28,32mm (BLK Insert)	MNK
20.342.20	25, 30mm	CP
20.342.41	25, 30mm	MNK
20.344.20	20, 25, 30mm	CP
20.344.41	20, 25, 30mm	MNK
20.345.20	20, 25mm	CP
20.345.41	20, 25mm	MNK
20.354.41	14, 18mm	MNK
20.355.41	15, 20mm	MNK
20.358.20	14mm	CP
20.358.41	14mm	MNK
20.405.41	25mm	MNK
20.414.20	20, 25mm	CP
20.414.21	20, 25mm	SCP
20.414.41	20, 25mm	MNK
20.416.41	20, 25mm	MNK
20.443.10	22mm	PB
20.443.20	22mm	CP
20.443.41	22mm	MNK
20.560.21	30x25mm	SCP
20.560.41	30x25mm	MNK
20.568.21	50x50mm	SCP
20.568.41	50x50mm	MNK
20.611.10	20, 25, 32mm	PB
20.611.20	20, 25, 32mm	CP
20.611.41	20, 25, 32mm	MNK
20.680.10	20, 25, 32, 38mm	PB
20.680.20	20, 25, 32, 38mm	CP
20.680.21	20, 25, 32, 38mm	SCP
20.680.41	20, 25, 32, 38mm	MNK
20.680.53	20, 25, 32, 38mm	IBMA
20.727.10	25, 32, 38, 45mm	PB
20.727.20	25, 32, 38, 45mm	CP
20.808.10	20, 25, 32mm	PB
20.808.20	20, 25, 32mm	CP
20.808.41	20, 25, 32mm	MNK
20.808.53	25mm	IBMA
20.818.20	15, 18, 21mm	CP
20.818.21	18mm	SCP
20.818.41	15, 18, 21mm	MNK
20.822.20	14, 18, 22mm	CP
20.822.41	14, 18, 22mm	MNK
20.828.20	15, 18, 21mm	CP
20.828.21	15, 18, 21mm	SCP
20.828.41	15, 18, 21mm	MNK
20.830.20	14mm	CP
20.830.41	14mm	MNK
20.850.55	Alum, 25, 38mm	SAA
20.8900.41	12mm	MNK
20.8902.20	15mm	CP
20.8902.41	15mm	MNK
20.8905.20	15mm	CP
20.8905.41	15mm	MNK



DANICO

020 7483 4477

CUPBOARD KNOBS/HANDLES

CUPBOARD KNOBS

20.444.10	25, 32, 38mm	PB
20.444.20	25, 32, 38mm	CP
20.444.41	25, 32, 38mm	MNK
20.478.10	12, 20mm	PB
20.480.10	20, 32mm	PB
20.485.10	32mm	PB
20.490.10	32, 38mm	PB
20.490.20	32, 38mm	CP
20.490.21	32, 38mm	SCP
20.496.10	32mm	PB
20.505.10	25, 32, 38, 50mm	PB
20.506.10	25, 32, 38, 42, 50mm	PB
20.540.10	32mm	PB
20.682.10	32, 38mm	PB
20.682.20	32, 38mm	CP
20.682.21	32, 38mm	SCP
20.682.53	32, 38mm	IBMA
20.900.10	32, 38mm	PB
20.910.10	32mm	PB

CUPBOARD HANDLES

22.115.10	88mm C-T-C	PB
22.180.10	100, 175mm	PB
22.184.82	100, 125, 160mm	
	Iron	BJP
22.254.10	112mm C-T-C	PB



CUPBOARD DROPS/HANDLES



CUPBOARD KNOBS

20.8656.03	34mm	ANTBR
------------	------	-------

RING HANDLES

21.140.03	Ring, 38, 48mm	ANTBR
21.140.10	Ring, 38, 48mm	PB
21.144.10	Ring, 35mm	PB
21.150.10	Ring, 35mm	PB
21.170.03	Dutch Drop, 20mm	ANTBR
21.180.10	Pedestal Handle 83 x 28mm	PB
21.185.10	Pedestal with Keyhole, 83 x 28mm	PB

CARRIAGE DROPS

21.240.10	Face-Fix, 38, 60mm	PB
21.242.10	Bolt-Fix, 38mm	PB
21.250.10	Face-Fix, 38, 60mm	PB
21.252.10	Bolt-Fix, 38mm	PB

DROP HANDLES

21.318.03	27x22mm	ANTBR
21.318.10	27x22mm	PB
21.400.03	45, 50mm	ANTBR
21.400.10	45, 50mm	PB
21.430.10	Ring, 42mm	PB

DRAWER HANDLES

22.155.10	75, 90mm	PB
22.160.10	90mm	PB
22.165.03	65, 75, 90mm	ANTBR
22.165.10	65, 75, 90mm	PB
22.170.03	65, 75, 90mm	ANTBR
22.170.10	65, 75, 90mm	PB
22.185.10	95x38mm	PB
22.185.20	95x38mm	CP
22.185.41	95x38mm	SNP
22.190.10	95mm	PB
22.190.20	95mm	CP
22.190.21	95mm	SCP
22.195.10	100mm	PB

ALSO SNP

ALSO SCP

CUPBOARD KNOBS/HANDLES

CUPBOARD KNOBS

20.2010.20	20, 25, 30, 35mm	CP
20.253.28	32, 38mm	PB/CP
20.253.34	32, 38mm	PB/SM
20.257.22	25, 32mm	MC/CP
20.257.28	25, 32mm	PB/CP
20.259.28	25, 32, 38mm	PB/CP
20.259.34	32, 38mm	PB/SM
20.281.20	20, 25, 30mm	CP
20.281.21	20, 25, 30mm	SCP
20.281.41	20, 25, 30mm	MNK
20.282.10	20, 25, 32mm	PB
20.282.20	20, 25, 32mm	CP
20.282.41	20, 25, 32mm	MNK
20.399.10	20mm	PB
20.399.20	20mm	CP

CUPBOARD HANDLES

CUPBOARD HANDLES	C-T-C	
22.113.20	352mm	CP
22.113.21	352mm	SCP
22.253.28	64, 96mm	PB/CP
22.253.34	64, 96mm	PB/SM
22.259.28	64, 96, 128mm	PB/CP
22.259.34	64, 76mm	PB/SM
22.269.14	88, 101mm	PB/NK
22.269.15	64, 76, 88, 96, 101mm	PB/CL
22.269.16	64, 96mm	PB/WH
22.269.26	64, 96mm	CP/WH
22.269.35	76, 88, 101mm	BK/CL
22.269.44	76, 88, 101mm	NK/PB
22.272.10	64mm	PB
22.272.20	64, 96mm	CP
22.276.14	64, 88, 96, 101mm	PB/NK
22.276.28	64, 96mm	PB/CP

C-T-C: Centre to Centre

DANICO

020 7483 4477



CUPBOARD KNOBS/HANDLES



GLASS CUPBOARD KNOBS		
20.118.15	25, 30, 35mm	PB/CL
20.118.25	25, 30, 35mm	CP/CL

CUPBOARD KNOBS		
20.253.34	32, 38mm	PB/SM
20.255.14	25, 32, 38mm	PB/NK
20.258.14	25, 32mm	PB/NK
20.258.15	25, 32mm	PB/CL
20.258.16	25, 32mm	PB/WH
20.258.25	25, 32mm	CP/CL
20.258.26	25, 32mm	CP/WH
20.258.28	25, 32mm	PB/CP
20.260.14	20, 32mm	PB/NK
20.260.28	20mm	PB/CP
20.260.39	20mm	BK/GO
20.261.14	32mm	PB/NK
20.269.12	28, 38mm	PB/BK
20.269.32	38mm	CP/BK
20.269.69	35mm	WH/GO
20.275.66	20, 26mm	CP/BG
20.279.34	16, 22mm	PB/SM
20.280.27	20, 25mm	CP/SM
20.280.66	24mm	CP/BG
20.287.28	20, 25mm	PB/CP

CUPBOARD HANDLES		C-T-C
22.141.20	96, 160, 256mm	CP
22.141.41	96, 160, 256mm	MNK
22.222.10	160mm	PB
22.222.28	96, 128, 160mm	PB/CP
22.258.15	64, 96, 101mm	PB/CL
22.258.16	64, 96mm	PB/WH
22.258.18	64, 96mm	PB/MN
22.258.25	64, 76, 96, 101mm	CP/CL
22.258.26	64, 76, 88, 96, 101mm	CP/WH
22.258.28	64, 96mm	PB/CP
22.258.49	64, 76, 96mm	NK/GO
22.299.10	96, 128mm	PB
22.299.20	96, 128mm	CP
22.299.41	96, 128mm	MNK
22.299.47	96mm	BLKNK
22.399.22	96, 128mm	MC/CP
22.399.28	96, 128mm	PB/CP
22.399.41	96, 128mm	MNK
22.408.22	96, 128mm	MC/CP
22.408.28	96, 128mm	PB/CP

FOR FURTHER INFORMATION ON FINISH DETAILS SEE PAGE 1

CUPBOARD HANDLES

CUPBOARD HANDLE	C-T-C
22.110.20	Steel 10mm Dia 64, 96, 128, 160, 192, 288, 352, 448, 512mm CP
22.110.41	(as above) MNK
22.110.80	(as above) EBP
22.112.20	Steel 10mm Dia Straight, 128mm CP
22.112.41	(as above) MNK
22.114.20	Steel 10mm Dia Bowed, 128mm CP
22.114.41	(as above) MNK
22.121.10	64, 96, 128mm Zinc PB
22.121.20	64, 96, 128mm Zinc CP
22.121.41	96, 128mm Zinc MNK
22.125.10	41mm Brass 10mm PB
22.125.20	41mm Brass 10mm CP
22.125.21	41mm Brass 10mm SCP
22.125.41	41mm Brass 10mm MNK
22.126.62	76, 88, 101mm BLACK
22.128.10	96, 128mm Zinc PB
22.128.20	96, 128mm Zinc CP
22.128.41	96, 128mm Zinc MNK
22.129.20	96, 128mm Zinc CP
22.129.41	96, 128mm Zinc MNK
22.136.20	96, 128mm Zinc CP
22.136.41	96, 128mm Zinc MNK
22.138.41	192mm Zinc MNK
22.138.62	96mm Zinc BLACK
22.228.51	96, 128, 160mm SSS

C-T-C: Centre to Centre



CUPBOARD KNOBS/HANDLES

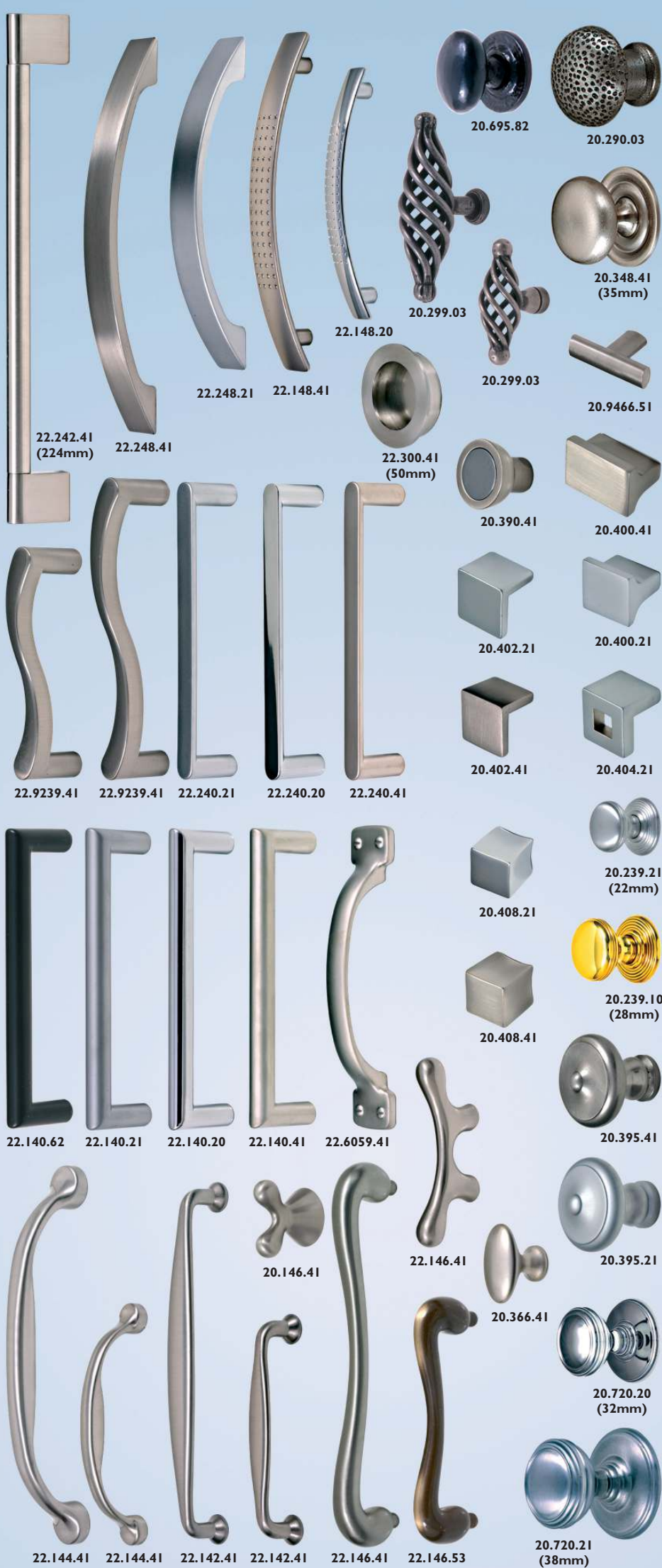

CUPBOARD KNOBS		
20.146.41	36mm	MNK
20.239.10	22, 28, 35mm	PB
20.239.20	22, 28, 35mm	CP
20.239.21	22, 28, 35mm	SCP
20.290.03	32, 38mm	ANT
20.299.03	Celtic Iron	
	55, 65, 80mm	PATIN
20.348.41	20, 24, 28, 35mm	MNK
20.366.41	20x32mm	MNK
20.390.20	28, 32mm (MNK Insert)	CP
20.390.41	28, 32mm (CP Insert)	MNK
20.395.10	40mm	PB
20.395.20	40mm	CP
20.395.21	40mm	SCP
20.395.41	40mm	MNK
20.400.21	25x25, 25x35mm	SCP
20.400.41	25x25, 25x35mm	MNK
20.402.21	25mm	SCP
20.402.41	25mm	MNK
20.404.21	25mm	SCP
20.404.41	25mm	MNK
20.408.20	15, 20mm	CP
20.408.21	15, 20mm	SCP
20.408.41	15, 20mm	MNK
20.695.82	38mm Iron	BJP
20.720.10	20, 25, 32, 38mm	PB
20.720.20	20, 25, 32, 38mm	CP
20.720.21	20, 25, 32, 38mm	SCP
20.9466.51	45mm	SSS

CUPBOARD HANDLES SIZES ARE C-T-C		
22.140.20	128mm	CP
22.140.21	128mm	SCP
22.140.41	128mm	MNK
22.140.62	128mm	BLACK
22.142.41	96, 160mm	MNK
22.144.41	96, 160mm	MNK
22.146.41	32, 96, 160mm	MNK
22.146.53	96, 160mm	IBMA
22.148.20	96, 128mm	CP
22.148.41	96, 128mm	MNK
22.240.20	128mm	CP
22.240.21	128mm	SCP
22.240.41	128mm	MNK
22.242.41	12mm dia Tube	
	192, 224, 288mm	MNK
22.248.21	128, 160mm	SCP
22.248.41	128, 160mm	MNK
22.300.10	Inset Handle, 40, 50mm	PB
22.300.20	40, 50mm	CP
22.300.41	40, 50mm	MNK
22.6059.41	96mm	MNK
22.9239.41	96, 128mm	MNK

CUPBOARD KNOBS/HANDLES

CUPBOARD KNOBS

20.127.20	12mm	CP
20.3303.20	32mm, Blue Dot	CP
20.3303.41	32mm, Blue Dot	MNK
20.3305.20	32mm, Black Dot	CP
20.3305.41	32mm, Black Dot	MNK
20.3338.20	32mm, Dark-Wood	CP
20.3342.20	20mm, Beech	CP

20.351.20	12mm	CP
20.351.41	12mm	MNK
20.356.20	14, 18mm	CP
20.356.41	14, 18mm	MNK
20.357.20	20mm	CP
20.357.41	20mm	MNK
20.359.10	17mm	PB
20.359.20	17mm	CP
20.359.41	17mm	MNK
20.388.20	12mm	CP
20.388.21	12mm	SCP
20.388.41	12mm	MNK

WOODEN CUPBOARD KNOBS

20.600.00	Beech, 32, 38, 45, 50mm	S/COL
20.602.00	Pine, 32, 38, 45, 50mm	S/COL
20.606.00	Beech, 25, 32, 38, 45mm	S/COL
20.619.00	Beech, 32, 38mm Pine, 45mm	S/COL
20.812.10	18mm	PB
20.812.20	18mm	CP
20.812.21	18mm	SCP
20.816.20	10mm	CP
20.816.41	10mm	MNK
22.131.20	128mm C-T-C	CP
22.131.41	128mm C-T-C	MNK
22.149.20	64, 96mm C-T-C	CP
22.149.21	64, 96mm C-T-C	SCP
22.192.41	96mm C-T-C	MNK
22.232.41	Steel, 12mm Ø C-T-C 96, 128, 159, 184, 234, 284, 334, 384, 434, 450, 484, 519, 595, 646, 775, 784, 860, 900,	MNK
	For overall length add 60mm	



CABINET HANDLES



FLUSH HANDLES

22.308.10	85x39mm, 115x43mm	PB
22.308.40	85x39mm, 115x43mm	NP
22.310.10	75, 90, 100mm (Also in CP & SCP)	PB
22.320.10	90, 100mm	PB
22.320.20	90, 100mm	CP
22.320.21	90, 100mm	SCP
22.320.41	90, 100mm	SNP
22.320.53	90, 100mm	IBMA
22.324.10	85x37mm	PB
22.325.10	232x34mm	PB
22.325.20	232x34mm	CP
22.325.21	323x34mm	SCP
22.350.10	Military Chest Handle, 65, 75, 90mm	PB
22.354.03	42, 55mm	ANTBR
22.354.10	42, 55mm	PB
22.354.20	42, 55mm	CP
22.360.10	Lifting Handle, 100mm	PB
22.370.10	Flush Ring Handle, 38x28mm, 44x32mm, 50x38mm, 65x50mm	PB
22.370.20	as above	CP
22.370.21	as above	SCP
22.375.10	Flush Ring Spring Catch, 50x38mm	PB
22.375.20	(as above)	CP
22.380.10	Flush Ring Handle, 38, 44, 50mm	PB
22.380.20	as above	CP
22.380.21	as above	SCP
22.390.10	Flush Handle, 102x51mm	PB
22.395.10	Flush Edge Handle, 125x20mm Shown in open and closed positions	PB
22.395.20	(as above)	CP
22.395.21	(as above)	SCP

CABINET ESCUTCHEONS

For Door Escutcheons see page 78 & 79.

For Cabinet Locks see page 90.

24.050.08	15, 18, 20mm	BB
24.060.11	12, 15, 20, 22mm	SAB
24.120.10	29mm	PB
24.120.40	29mm	NP
24.140.10	28mm	PB
24.160.10	32mm	PB
24.200.13	27mm	PB/UL
24.220.10	35x20mm,	
	40x22mm	PB
24.220.40	37x20mm	NP
24.220.41	37x20mm	MNK
24.240.10	45x21mm	PB
24.240.20	45x21mm	CP
24.260.03	42x25mm	ANTBR
24.260.10	42x25mm	PB
24.290.10	32mm	PB
24.300.10	32, 40mm	PB
24.320.10	40mm	PB
24.400.10	Budget Lock, 25mm	PB
24.400.20	Budget Lock, 25mm	CP
24.480.10	For Security Bolt,	
	40mm	PB
24.480.20	For Security Bolt,	
	40mm	CP
24.480.21	For Security Bolt,	
	40mm	SCP

FOR FURTHER INFORMATION ON FINISH DETAILS SEE PAGE 1



**CABINET
HARDWARE**

CABINET CATCHES



CABINET HARDWARE



SHELF BRACKETS



METAL PROFILES



TUBE FITTINGS

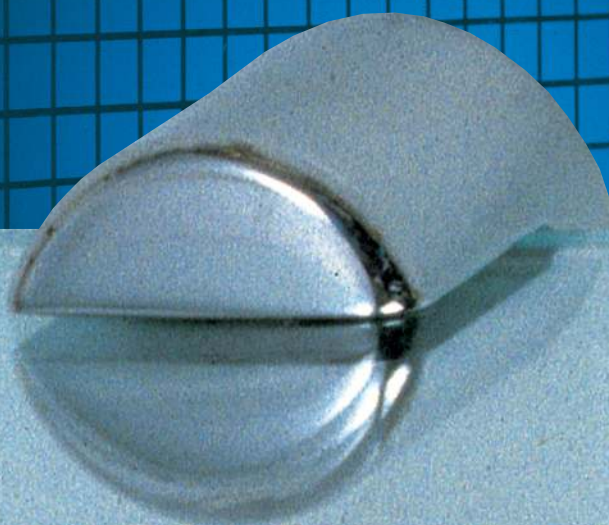

CABINET HARDWARE/ MISCELLANEOUS

25.1000.08	Bullet Ball Catch	
	1/4", 5/16", 3/8", 1/2"	BB
25.1200.08	Bales Catch	
	3/8", 1/2", 5/8", 3/4", 7/8"	BB
25.1400.60	Mini Tip Catch	WH
25.1400.63	Mini Tip Catch	BRWV
25.1410.60	Magn.Tutch Catch	WH
25.1410.63	Magn.Tutch Catch	BRWV
25.1480.10	Double Ball Catch	
	40, 50, 60, 70mm	PB
25.1480.20	(As above)	CP
25.1506.60	Magn. Catch, 6kg	WH
25.1506.63	Magn. Catch, 6kg	BRWV
25.1514.60	Magn. Catch, 12mm	WH
25.1604.60	Magn. Catch, 4kg	WH
25.1604.63	Magn. Catch, 4kg	BRWV
25.1606.60	Magn. Catch, 6kg	WH
25.1606.63	Magn. Catch, 6kg	BRWV
25.1700.00	Gripper Catch	S/COL
25.1720.81	Double Roller Catch	BZP

ADJUSTABLE ROLLER CATCH

25.1950.40	Nylon Roller,	NP
25.1950.80	Nylon Roller,	EBP
25.1960.40	Brass Roller,	NP
25.1960.80	Brass Roller,	EBP
25.1974.10	Holro Catch,	PB
25.1974.21	Holro Catch,	SCP
25.1980.10	Ball-Bearing	PB
25.1980.51	Ball-Bearing	SSS

25.2000.10	Turn Button, 50mm	PB
25.2010.08	Turn Button, 38mm	BB
25.2030.08	Photo Frame Turn, 25mm	BB

25.2110.10	Counterflap Catch	PB
25.2110.20	Counterflap Catch	CP
25.2120.10	Throw-over Catch,	PB
25.2120.20	Throw-over Catch,	CP
25.2130.10	Oval Fastener 50mm	PB
25.2130.20	Oval Fastener 50mm	CP
25.2130.21	Oval Fastener 50mm	SCP
25.2140.10	Tee Fastener 40mm	PB
25.2150.10	Tee Fastener 50mm	PB
25.2150.20	Tee Fastener 50mm	CP
25.2180.10	Tee Fastener 65mm	PB
25.2180.20	Tee Fastener 65mm	CP
25.2820.10	Secretaire 57x32mm	PB
25.2840.11	Table Fork, 75mm	SAB
25.2850.10	Banjo Catch, 65mm	PB
25.2880.11	Table Catch, 65mm	SAB

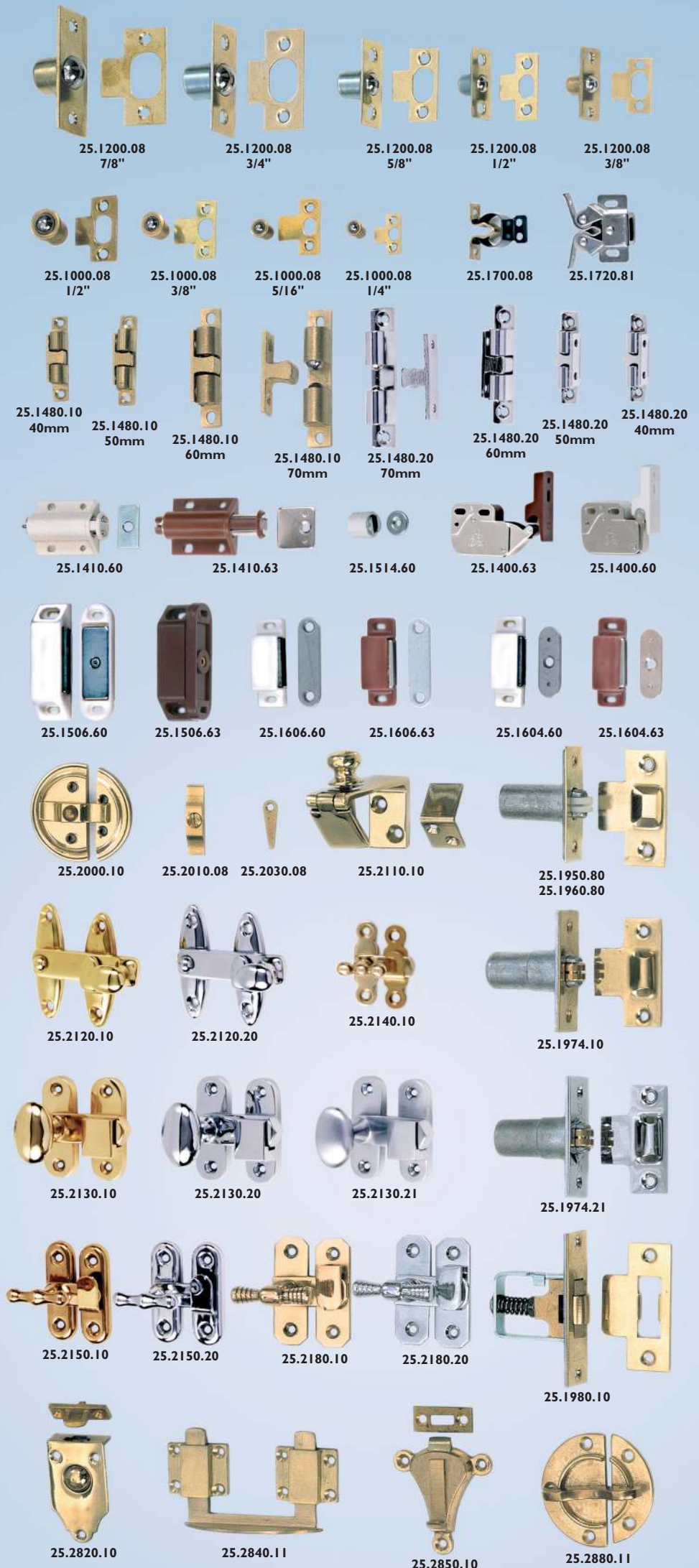

CABINET HARDWARE/ MISCELLANEOUS

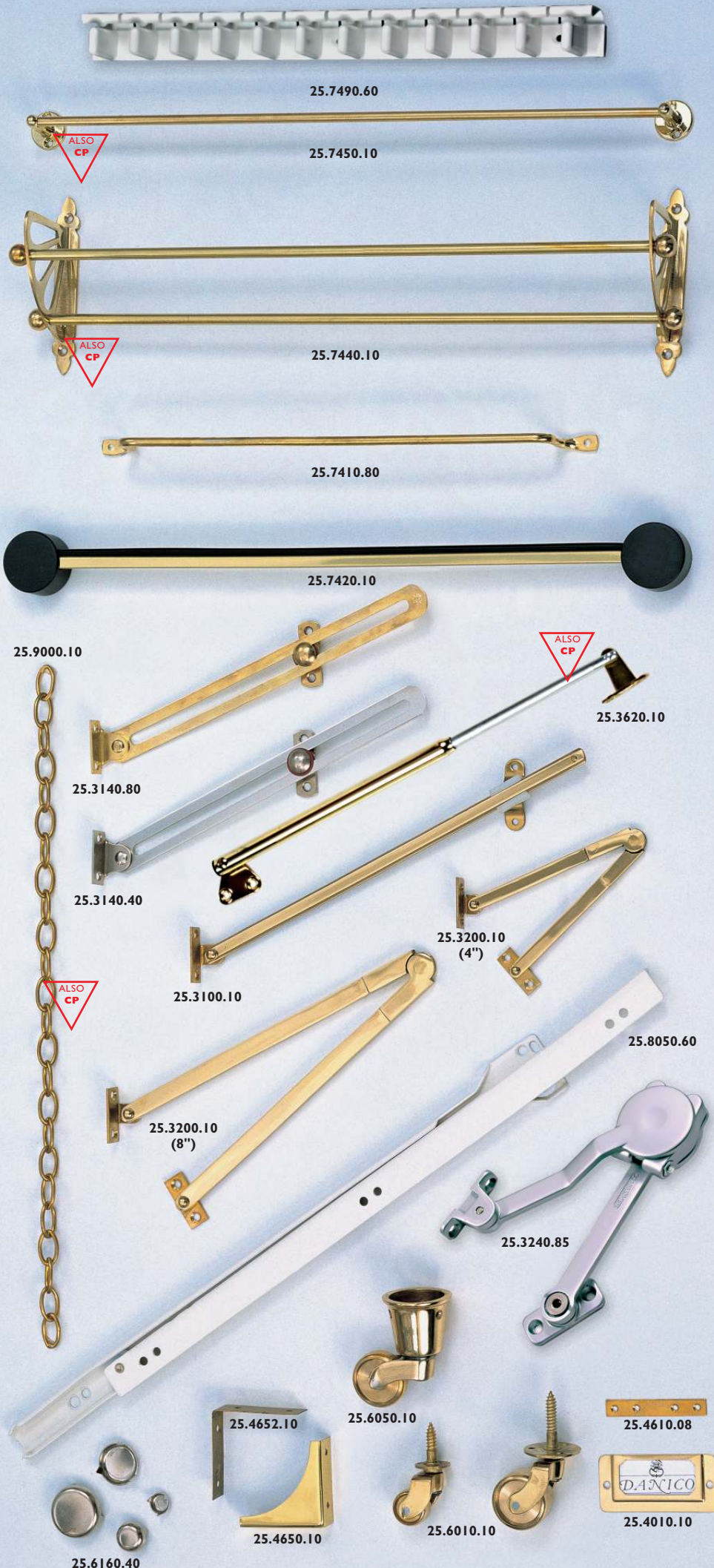

25.3100.10	Sliding Stay, 250mm	PB
25.3140.40	Steel, Sliding Stay, 215mm	NP
25.3140.80	Steel, Sliding Stay, 215mm	EBP
25.3200.10	Brass Joint Stay, 3", 4", 6", 8"	PB
25.3240.85	Lift-up Flap Stay (L or R)	SE
25.3620.10	Piston Stay 250mm	PB
25.3620.20	Piston Stay 250mm	CP
25.4010.10	Card Frame, 48x15mm, 50x25mm, 75x38mm	PB
25.4610.08	Repair Plate, 57x10mm	BB
25.4650.10	Top Corner, 50x15mm	PB
25.4652.10	Strap, 50x15mm	PB
25.6010.10	Castors, Screw Plate, 3/4", 1", 1 1/4", 1 1/2"	PB
25.6050.10	Castors, Round Cup, 1", 1 1/8", 1 1/4"	PB
25.6160.40	Dome of Silence, 12, 20, 25, 32mm	NP
TIE RACKS		
25.7410.80	300mm Steel	EBP
25.7420.10	400mm	PB
25.7440.10	Double, 360mm	PB
25.7440.20	Double, 360mm	CP
25.7450.10	435mm	PB
25.7450.20	435mm	CP
25.7490.60	Belt Rack	WH
DRAWER SLIDES		
25.8030.60	Drawer Slide 300mm	WH
25.8035.60	Drawer Slide 350mm	WH
25.8040.60	Drawer Slide 400mm	WH
25.8045.60	Drawer Slide 450mm	WH
25.8050.60	Drawer Slide 500mm	WH
25.8055.60	Drawer Slide 550mm	WH
25.8060.60	Drawer Slide 600mm	WH
OVAL LINK CHAINS		
25.9000.10	10, 12, 15, 20, 25, 32mm	PB
25.9000.20	10, 12, 15, 20mm	CP

BRACKETS ETC

SHELF BRACKETS

26.1500.10	For Wood, 100, 144, 194mm	PB
26.1510.10	For Glass, 100, 144, 194mm	PB
26.1510.20	For Glass, 144mm	CP
26.1620.20	For Glass, 150mm	CP
26.1620.41	For Glass, 150mm	MNK
26.1640.20	For Wood, 240mm	CP
26.1650.20	For Glass, 150mm	CP
26.1650.41	For Glass, 150mm	MNK
26.1660.20	For 6 -10mm Glass, 66mm	CP
26.1660.41	(as above)	MNK
26.1690.85	Clamp Bracket 110mm SE	
26.1700.82	For Wood, 150, 200mm	BJP
26.1750.60	Steel, 4x3", 6x5", 8x6", 10x8"	VH

HANDRAIL BRACKETS

26.2210.10	65mm	PB
26.2212.10	65, 75mm	PB
26.2212.20	65, 75mm	CP
26.2212.21	65, 75mm	SCP
26.2220.55	Aluminium, 65mm	SAA
26.2240.51	S/Steel to suit Tube, 38, 50mm Ø	SSS
26.2250.10	For Tube, 75mm	PB

BOOKCASE STRIPS FLAT

26.3000.10	Brass, 72"	PB
26.3000.20	Brass, 72"	CP
26.3000.53	Steel, 72"	IBMA
26.3000.55	Aluminium, 72"	SAA
26.3000.80	Steel, 72"	EBP
26.3000.81	Steel, 72"	BZP

BOOKCASE STRIP UNIVERSAL

(Illustrated on opposite page 33)

26.3020.10	Brass, 72"	PB
26.3020.53	Steel, 72"	IBMA
26.3020.55	Aluminium, 72"	SAA
26.3020.80	Steel, 72"	EBP
26.3020.81	Steel, 72"	BZP

BOOKCASE STRIP SHELF SUPPORTS

(Illustrated on opposite page 33)

26.3030.10	Brass	PB
26.3030.53	Steel	IBMA
26.3030.80	Steel	EBP
26.3030.81	Steel	BZP
26.3045.00	Rubber Pads	Black
26.3050.80	Strong, Steel	EBP
26.3050.81	Strong, Steel	BZP

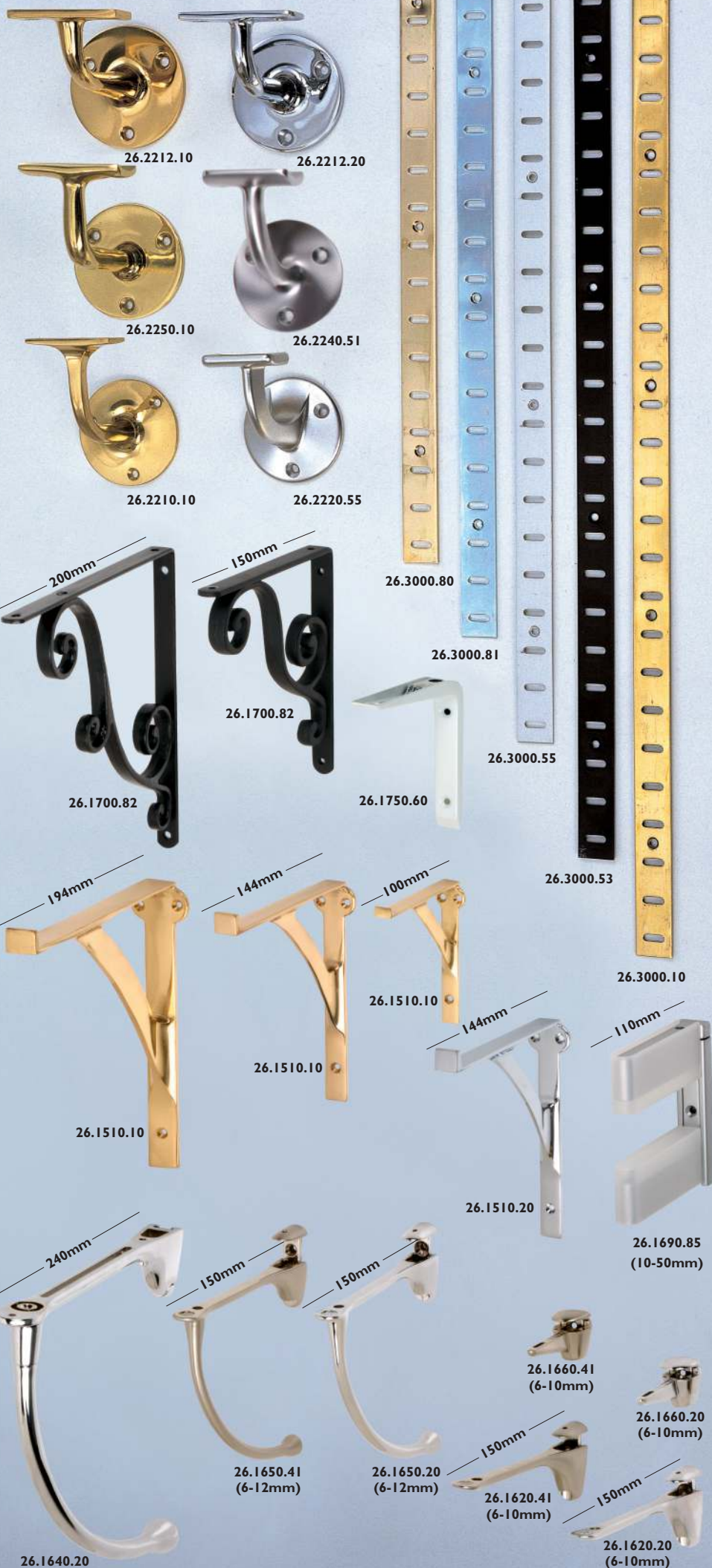

BRACKETS ETC

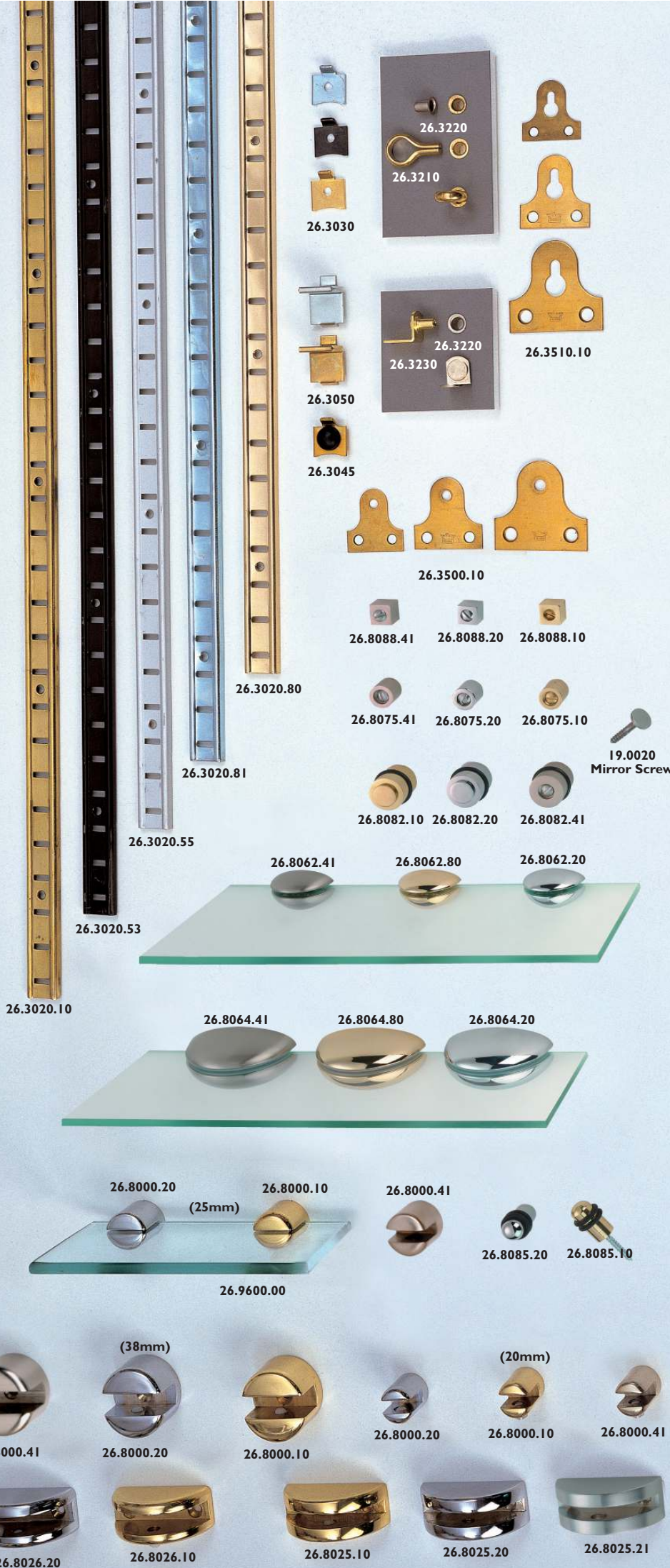

BANJO STUDS & SOCKETS

26.3210.40	Stud	NP
26.3210.80	Stud	EBP
26.3220.40	Socket	NP
26.3220.80	Socket	EBP
26.3230.40	Angle Stud	NP
26.3230.80	Angle Stud	EBP
GLASSPLATES		
26.3500.10	Plain, 32, 38, 50mm	PB
26.3510.10	Slotted, 32, 38, 50mm	PB

BRACKETS FOR GLASS SHELVES

26.8000.10	20x6mm, 25x6mm, 38x10mm	PB
26.8000.20	(as above)	CP
26.8000.41	(as above)	MNK
26.8025.10	50mmx6mm	PB
26.8025.20	50mmx6mm	CP
26.8025.21	50mmx6mm	SCP
26.8026.10	50mmx10mm	PB
26.8026.20	50mmx10mm	CP
26.8026.21	50mmx10mm	SCP
26.8062.20	40mm Suits 6-8mm	CP
26.8062.41	40mm Suits 6-8mm	MNK
26.8062.80	40mm Suits 6-8mm	EBP
26.8062.85	40mm Suits 6-8mm	SE
26.8064.20	74mm Suits 6-10mm	CP
26.8064.41	74mm Suits 6-10mm	MNK
26.8064.80	74mm Suits 6-10mm	EBP

GLASS SUPPORTS

26.8075.10	Round, 12mm	PB
26.8075.20	Round, 12mm	CP
26.8075.41	Round, 12mm	MNK
26.8082.10	With O Ring, 20mm	PB
26.8082.20	With O Ring, 20mm	CP
26.8082.41	With O Ring, 20mm	MNK
26.8085.10	Dble O Ring, 12mm	PB
26.8085.20	Dble O Ring, 12mm	CP
26.8085.21	Dble O Ring, 12mm	SCP
26.8088.10	Cube, 10mm	PB
26.8088.20	Cube, 10mm	CP
26.8088.41	Cube, 10mm	MNK

GLASS SHELVES

26.9600.00	Glass shelf, 6mm thick, 500mm, 600mm	CLEAR
26.9610.00	Glass Shelf, 10mm thick 500mm, 600mm	CLEAR

METAL PROFILES

CONVERSION TABLE FOR THICKNESS

20G = 0.91mm
 16G = 1.62mm
 10G = 3.25mm

All Polished Brass items on this page are supplied Un-Lacquered
 All Stainless Steel items are available Polished or Satin

BRASS STRIPS 20G (.9MM) 2 MTR LONG

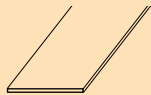

27.0012.10	1/2" wide	PB
27.0020.10	3/4" wide	PB
27.0025.10	1" wide	PB
27.0030.10	1 1/4" wide	PB
27.0038.10	1 1/2" wide	PB
27.0045.10	1 3/4" wide	PB
27.0050.10	2" wide	PB
27.0065.10	2 1/2" wide	PB
27.0075.10	3" wide	PB
27.0099.10	4" wide	PB

STAINLESS STEEL EQUAL ANGLES 20G 2 MTR LONG

27.1212.50	1/2"	PSS
27.1220.50	3/4"	PSS
27.1225.50	1"	PSS

BRASS UNEQUAL ANGLES 20G 2 MTR LONG

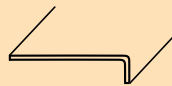

27.1612.10	1/4x1/2"	PB
27.1620.10	1/4x3/4"	PB
27.1625.10	1/4x1"	PB

CARPET EDGING

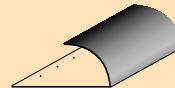

27.2004.10	32" Long Brass	PB
27.2064.10	2 Mtr Long Brass	PB

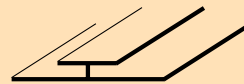

27.2005.10	32" Long	PB
------------	----------	----

Also available in Stainless Steel

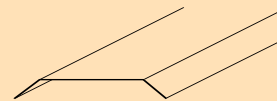

27.2006.10	32" Long Brass	PB
27.2066.10	2 Mtr Long Brass	PB

STAINLESS STEEL KICK PLATES

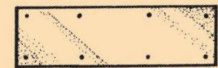

27.4200.50	Standard size, 30x6"	
	20G	PSS
27.4216.50	Made to Measure 16G	PSS
27.4220.50	Made to Measure 20G	PSS

ALUMINIUM KICK PLATES



27.4400.55	Standard size, 30x6"	
	16G	SAA
27.4416.55	Made to Measure 16G	SAA

STAINLESS STEEL STRIPS 20G 2 MTR LONG

27.0112.50	1/2" wide	PSS
27.0120.50	3/4" wide	PSS
27.0125.50	1" wide	PSS
27.0138.50	1 1/2" wide	PSS
27.0150.50	2" wide	PSS
27.0175.50	3" wide	PSS

CARPET EDGING

Also available in Stainless Steel

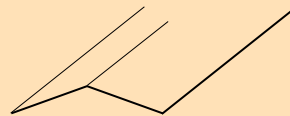

27.2001.10	32" Long Brass	PB
27.2061.10	2 Mtr Long Brass	PB

Also available in Stainless Steel

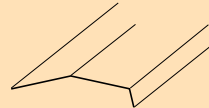

27.2002.10	32" Long Brass	PB
27.2062.10	2 Mtr Long Brass	PB

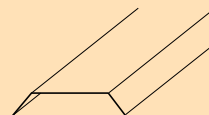

27.2003.10	32" Long Brass	PB
27.2063.10	2 Mtr Long Brass	PB

BRASS KICK PLATES



27.4000.10	Standard size, 30x6"	
	20G, (.9mm)	PB
27.4010.10	Made to Measure	
	10G, (3.2mm)	PB
27.4016.10	Made to Measure	
	16G, (1.6mm)	PB
27.4020.10	Made to Measure	
	20G, (.9mm)	PB

STEP EDGES/NOSING

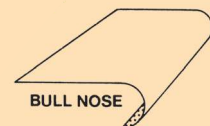
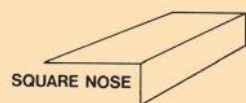

MADE TO MEASURE		
27.4120.10	Brass 20G	PB
27.4320.50	Stainless Steel 20G	PSS
27.4320.51	Stainless Steel 20G	SSS

BRASS EQUAL ANGLES 20G 2 MTR LONG

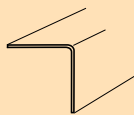









27.1112.10	1/2"	PB
27.1120.10	3/4"	PB
27.1125.10	1"	PB
27.1130.10	1 1/4"	PB
27.1138.10	1 1/2"	PB
27.1150.10	2"	PB

ONLY SOME SIZES ARE AVAILABLE FROM STOCK
PLEASE CHECK FOR AVAILABILITY

BRASS EXTRUSIONS

Brass Extrusions 12 feet long. All supplied self-coloured (mill finish unpolished)

	27.7002.00 Flat Strip $\frac{1}{8}$ " Thick $\frac{3}{8}, \frac{1}{2}, \frac{3}{4}, 1, 1\frac{1}{4}, 1\frac{1}{2}, 2"$		27.7021.00 Unequal Angles $\frac{1}{16}$ " Thick $\frac{3}{4} \times \frac{3}{8}, 1 \times \frac{1}{4}, 1 \times \frac{1}{2}"$		27.7041.00 Equal U Channel $\frac{1}{16}$ " Thick $\frac{3}{8}, \frac{5}{8}, \frac{3}{4}, \frac{7}{8}, 1"$		27.7090.00 10ft Round Bar, $\frac{3}{16}, \frac{1}{4}, \frac{3}{8}, \frac{1}{2}, \frac{5}{8}"$
	27.7003.00 Flat Strip $\frac{3}{16}$ " Thick $\frac{3}{4}, 1"$		27.7022.00 Unequal Angles $\frac{1}{8}$ " Thick $1\frac{1}{2} \times 1, 2 \times 1"$		27.7042.00 Equal U Channel $\frac{1}{8}$ " Thick $\frac{1}{2}, \frac{5}{8}, \frac{3}{4}, 1"$		
	27.7004.00 Flat Strip $\frac{1}{4}$ " Thick $\frac{1}{2}, \frac{3}{4}, 1, 1\frac{1}{4}, 1\frac{1}{2}"$		27.7024.00 Unequal Angles $\frac{1}{4}$ " Thick $4 \times 2"$		27.7052.00 Unequal Channel $\frac{1}{8}$ " Thick $\frac{1}{2} \times 1 \times \frac{1}{2}"$		
	27.7011.00 Equal Angles $\frac{1}{16}$ " Thick $\frac{1}{2}, \frac{3}{4}, 1"$		27.7061.00 Equal Tees $\frac{1}{16}$ " Thick $\frac{1}{2} \times \frac{1}{2}, \frac{3}{4} \times \frac{3}{4}"$		27.7080.00 10ft Square Bar, $\frac{3}{16}, \frac{1}{4}, \frac{3}{8}, \frac{1}{2}, \frac{3}{4}"$		27.7106.00 10ft Half-Round Bar, $\frac{1}{4} \times \frac{1}{2}, \frac{3}{8} \times \frac{3}{4}"$
	27.7012.00 Equal Angles $\frac{1}{8}$ " Thick $\frac{1}{2}, \frac{5}{8}, \frac{3}{4}, 1, 1\frac{1}{4}, 1\frac{1}{2}"$		27.7062.00 Equal Tees $\frac{1}{8}$ " Thick $1 \times 1"$				
	27.7014.00 Equal Angles $\frac{1}{4}$ " Thick $1\frac{1}{2}, 2, 3"$						



ALUMINIUM SLIDING GLASS TRACK SYSTEM



27.8500.55
Top Channel



27.8540.55
Cylinder lock LH or RH
with two keys

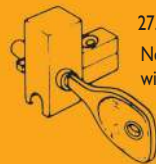

27.8526.55
Non-handed lock
with two keys

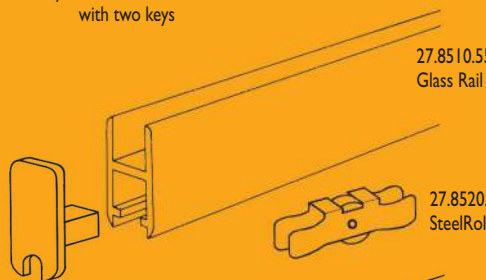

27.8510.55
Glass Rail



27.8525.55
Endcap



27.8520.00
Steel Roller

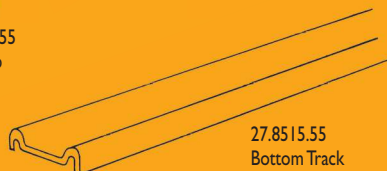

27.8515.55
Bottom Track

27.8500.55	Aluminium Top Channel	SAA
27.8510.55	Aluminium Glass Rail	SAA
27.8515.55	Aluminium Bottom Track	SAA
27.8520.00	Steel Rollers	S/COL
27.8525.55	End Cap	SAA
27.8526.55	End Cap & Lock	SAA
27.8540.55	End Cap & Push Button Lock	SAA

ROUND BLANKS



27.7501.00	$\frac{1}{16}$ " Thick Brass 32, 38, 45, 50, 63, 75mm Diameter
27.7502.00	$\frac{1}{8}$ " Thick Brass 50, 75mm Diameter
27.7503.00	$\frac{3}{16}$ " Thick Brass 45, 50, 75, 100mm Dia
27.7504.00	$\frac{1}{4}$ " Thick Brass 50, 75, 100, 145mm Dia

TUBES & FITTINGS

ALL ITEMS ARE MADE FROM BRASS,
EXCEPT WHERE STATED

TUBES



28.0100.10 Brass Cased, Tube
 $\frac{3}{8}, \frac{1}{2}, \frac{3}{4}, 1,$
 $1\frac{1}{4}, 1\frac{1}{2}$ " PB



28.0200.80 Steel, Brass Plated,
 $\frac{3}{4}, 1$ " EBP

28.0300.20 Steel, Chrome Plated,
 $\frac{1}{2}, \frac{3}{4}, 1, 1\frac{1}{4}, 1\frac{1}{2}$ " CP



28.0400.00 Solid Brass, $\frac{1}{2}, \frac{3}{4}, 1,$
 $1\frac{1}{4}, 1\frac{1}{2}, 2$ " S/COL

28.0400.10 Solid Brass, $\frac{1}{2}, \frac{3}{4}, 1,$
 $1\frac{1}{4}, 1\frac{1}{2}, 2$ " PB

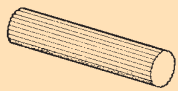

28.0600.00 Solid Brass Reeded,
 $\frac{1}{2}, 1\frac{1}{2}$ " S/COL

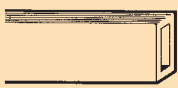

28.0816.00 Solid Brass Square,
 $\frac{3}{4}, 1, 1\frac{1}{2}, 2$ " S/COL

FITTINGS

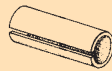

28.0900.00 Tube Joint Sleeve,
Steel $1\frac{1}{2}, 2$ " S/COL



28.0910.00 Spring Insert for
Tube, Steel $\frac{1}{2}, \frac{3}{4}, 1,$
 $1\frac{1}{4}, 1\frac{1}{2}, 2$ " S/COL

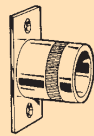

28.1010.08 Rod Bracket, Straight
 $\frac{3}{8}, \frac{1}{2}, \frac{3}{4}, 1$ " BB

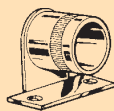

28.1020.08 Rod Bracket, Cranked
 $\frac{3}{8}, \frac{1}{2}, \frac{3}{4}, 1$ " BB

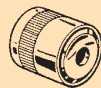

28.1040.08 Rod Bracket,
Backless $\frac{1}{2}$ " BB

28.1040.20 as above CP

FITTINGS



28.1200.08 Brass Tube Socket,
Pressed $\frac{1}{2}, \frac{3}{4}, 1$ " BB

28.1200.20 as above CP



28.1400.10 Brass Centre Bracket,
 $\frac{3}{4}, 1$ " PB

28.1400.20 as above CP

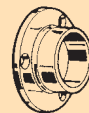

28.1500.10 Brass Tube Socket,
Forged, $\frac{1}{2}, \frac{5}{8}, \frac{3}{4}, 1,$
 $1\frac{1}{4}, 1\frac{1}{2}, 2$ " PB

28.1500.20 as above CP

28.1500.20 as above CP

28.1520.10 Brass Tube Socket,
 $1, 1\frac{1}{4}, 1\frac{1}{2}$ " PB

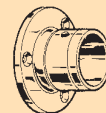

28.1600.10 Brass Tube Socket, Deep-
Neck, $1, 1\frac{1}{4}, 1\frac{1}{2}, 2$ " PB

28.1600.20 as above CP

FITTINGS



28.1800.20 Steel Tube Socket,
Conceal Fix, $\frac{3}{4}, 1$ " CP

28.1800.80 as above EBP



28.2010.10 Tube Bracket, Closed,
 $\frac{3}{8}, \frac{1}{2}, \frac{3}{4}, 1$ " PB

28.2010.20 as above CP

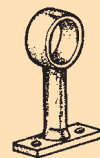

28.2012.10 Tube Bracket, Open,
 $\frac{3}{8}, \frac{1}{2}, \frac{3}{4}, 1$ " PB

28.2012.20 as above CP



28.2030.10 Tube Bracket, Heavy,
Closed, $1, 1\frac{1}{4}, 1\frac{1}{2}$ " PB

28.2030.20 as above CP

TUBES & FITTINGS

FITTINGS



28.2032.10 Tube Bracket, Heavy,
Open, 1, 1 1/4, 1 1/2" PB
28.2032.20 as above CP



28.2040.10 Tube Bracket,
Closed, 2" PB



28.2042.10 Tube Bracket,
Open, 2" PB



28.2080.20 Zinc, Die-Cast,
End Bracket,
1/2, 3/4, 1" CP



28.2082.20 Zinc, Die-Cast, Open
Bracket, 1/2, 3/4, 1" CP

FOOTRAIL BRACKETS



28.2052.10 Open, 156mm, to suit
1 1/2, 2" diameter PB

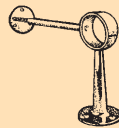

28.2062.10 Side Stem, Open,
156mm, to suit
1 1/2, 2" diameter PB

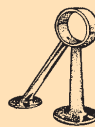

28.2070.10 Angle Stem, Open,
156mm, to suit
1 1/2, 2" diameter PB

TUBE CONNECTOR FITTINGS



28.5000.10 Ball End Cap,
1, 1 1/2, 2" PB

TUBE CONNECTOR FITTINGS



28.5010.10 Elbow, 1, 1 1/2, 2" PB



28.5020.10 Elbow, 3 Way
1, 1 1/2, 2" PB



28.5030.10 Tee, 1, 1 1/2, 2" PB



28.5040.10 Tee, 4 Way,
1, 1 1/2, 2" PB



28.5050.10 Cross, 4 Way,
1, 1 1/2, 2" PB

TUBE CONNECTOR FITTINGS



28.5060.10 Cross, 5 Way,
1, 1 1/2, 2" PB



28.5070.10 Elbow, 135 Degrees,
1, 1 1/2, 2" PB



8.5080.10 Tee, 135 Degrees,
1, 1 1/2, 2" PB



28.5190.10 Dome End Cap,
1, 1 1/2, 2" PB



28.5200.10 End Cap, 1, 1 1/2, 2" PB

TUBES & FITTINGS

TUBE CONNECTOR FITTINGS



28.5210.10 Inset Elbow, Curved,
1, 1 1/2, 2" PB



28.5214.10 Inset Elbow, Square,
1, 1 1/2, 2" PB



28.5220.10 Inset 3 Way Elbow,
1, 1 1/2, 2" PB

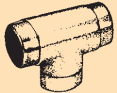

28.5230.10 Inset Tee,
1, 1 1/2, 2" PB



28.5240.10 Inset 4 Way Tee,
1, 1 1/2, 2" PB



28.5250.10 Inset 4 Way Cross,
1, 1 1/2, 2" PB

TUBE CONNECTOR FITTINGS



28.5270.10 Inset Elbow,
135 degrees,
1, 1 1/2, 2" PB



28.5500.10 Scroll End Plug,
1 1/2, 2" PB



28.5540.10 Straight Saddle, 2" PB

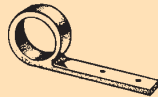

28.5560.10 Arm-Rail Bracket, 2" PB

CURTAIN RAIL FITTINGS

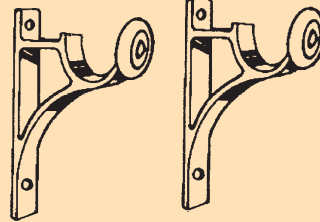

28.7000.10 Curtain Pole Bracket,
3/4, 1, 1 1/4, 1 1/2, 2" PB



28.7010.10 Centre Support Bracket,
1 1/4, 1 1/2" PB



28.7020.10 Ribbed Ball End,
1, 1 1/4, 1 1/2, 2" PB

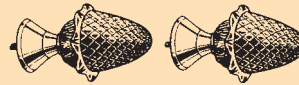

28.7030.10 Pineapple End, to suit
1 1/4, 1 1/2" PB



28.7080.10 Curtain Ring to suit,
3/4, 1, 1 1/4, 1 1/2, 2" PB

CURTAIN TIEBACKS

28.7150.10 75mm PB

28.7160.10 75mm PB

28.7185.10 200mm PB

Please ask for further details



28.7190.10 75mm PB



28.7195.10 200mm PB

BRASS STAIRODS



28.9500.10 1/2" diameter
made to measure PB

28.9510.10 Bracket, 3/8 or 1/2" PB

28.9610.10 Bracket, Heavy, 1/2" PB

28.9620.10 Bracket, Hinged, 1/2" PB

BARRIER ROPES & STAND

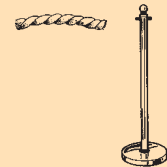

28.9900.10 Stand, 36x1 1/2" PB

28.9900.20 Stand, 36x1 1/2" CP

28.9920.00 Rope,
(Colours on request)
1, 1 1/4, 1 1/2" diameter

CASEMENT WINDOW FITTINGS



SASH WINDOW FITTINGS



DOOR STOPS



HOOKS



HINGES



BOLTS



VENTS

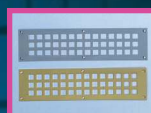

WINDOW HARDWARE

CARE INSTRUCTIONS
See page 2

CASEMENT WINDOW FITTINGS (FORGED)

30.1010.10	Stay, 8", 10", 12"	PB
30.1010.20	Stay, 8", 10", 12"	CP
30.1010.21	Stay, 8", 10", 12"	SCP
30.1014.10	Fastener with Hook & Mortise Plate	PB
30.1014.20	Fastener with Hook & Mortise Plate	CP
30.1014.21	Fastener with Hook & Mortise Plate	SCP
30.1016.10	Fastener Wedge Plate	PB
30.1016.20	Fastener Wedge Plate	CP
30.1016.21	Fastener Wedge Plate	SCP

CASEMENT WINDOW FITTINGS (SAND-CAST)

30.1050.10	Stay, 8", 10", 12"	PB
30.1114.10	Fastener with Hook & Mortise Plate	PB



WINDOW HARDWARE

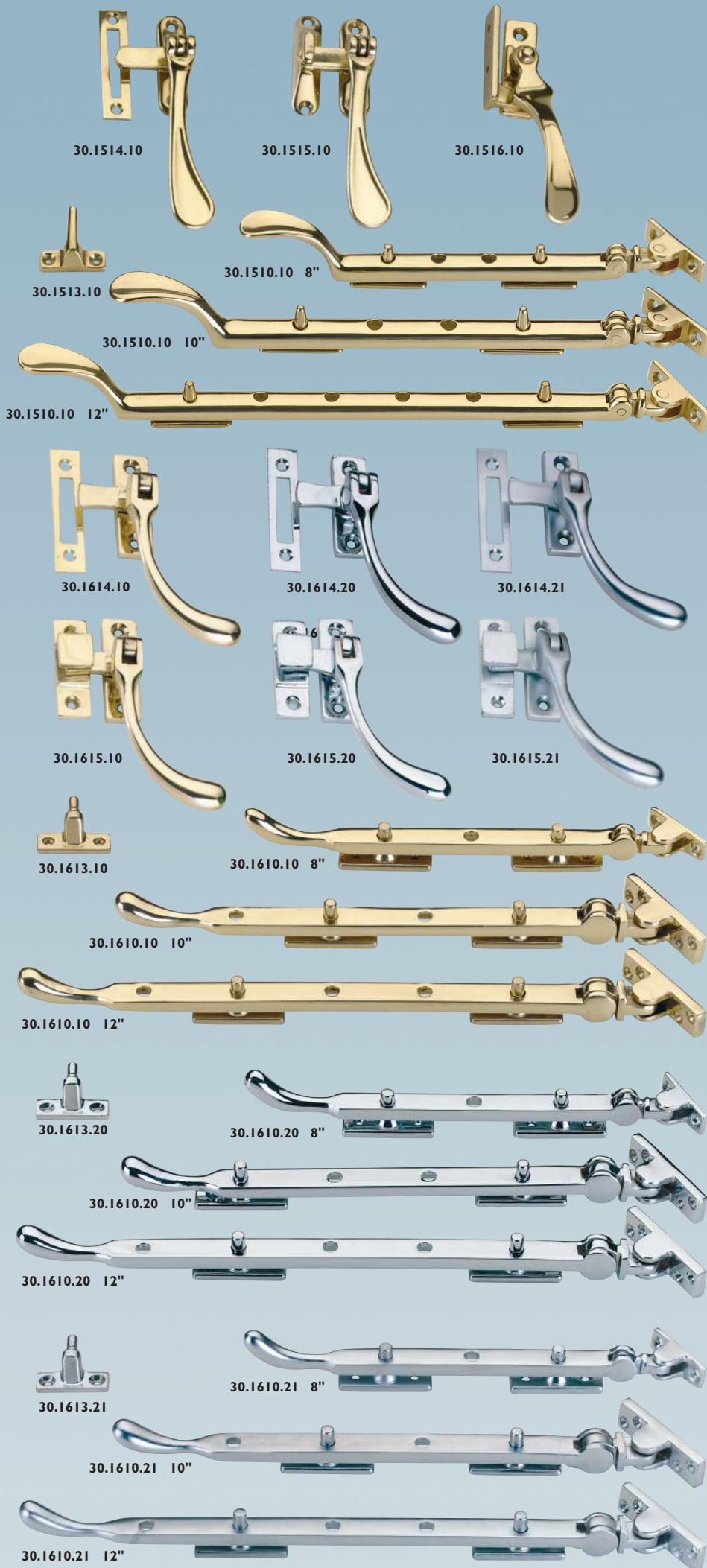

CASEMENT WINDOW FITTINGS (FORGED)

30.1510.10	Stay, 8", 10", 12"	PB
30.1513.10	Cranked Pin only	PB
30.1514.10	Fastener Mortise Plate	PB
30.1515.10	Fastener Hook Plate	PB
30.1516.10	Fastener Wedge Plate	PB

30.1610.10	Stay, 8", 10", 12"	PB
30.1610.20	Stay, 8", 10", 12"	CP
30.1610.21	Stay, 8", 10", 12"	SCP
30.1613.10	Cranked pin only	PB
30.1613.20	Cranked pin only	CP
30.1613.21	Cranked pin only	SCP
30.1614.10	Fastener Mortise Plate	PB
30.1614.20	Fastener Mortise Plate	CP
30.1614.21	Fastener Mortise Plate	SCP
30.1615.10	Fastener Hook Plate	PB
30.1615.20	Fastener Hook Plate	CP
30.1615.21	Fastener Hook Plate	SCP

WINDOW HARDWARE



30.1264.10



30.1264.20



30.1264.21



30.1260.10 8"



30.1260.20 10"



30.1260.21 12"



30.1865.82



30.1864.82



30.1855.82



30.1854.82



30.1850.82 10"



30.1850.82 12"



30.1860.82 10"



30.1860.82 12"



30.1816.55

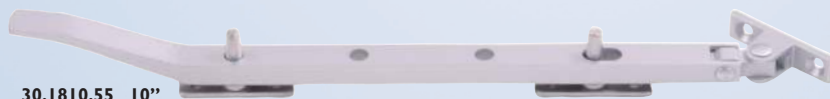

30.1810.55 10"



30.1810.55 12"

CASEMENT WINDOW FITTINGS

30.1260.10	Stay, 8", 10", 12"	PB
30.1260.20	Stay, 8", 10", 12"	CP
30.1260.21	Stay, 8", 10", 12"	SCP
30.1264.10	Fastener	
	Mortise Plate	PB
30.1264.20	Fastener	
	Mortise Plate	CP
30.1264.21	Fastener	
	Mortise Plate	SCP
30.1810.55	Stay, Aluminium, 10", 12"	SAA
30.1816.55	Fastener	
	Wedge Plate	SAA
30.1850.82	Stay, Iron, 10", 12"	BJP
30.1854.82	Fastener	
	Mortise Plate	BJP
30.1855.82	Fastener Hook Plate	BJP
30.1860.82	Stay, Iron, 10", 12"	BJP
30.1864.82	Fastener	
	Mortise Plate	BJP
30.1865.82	Fastener Hook Plate	BJP

WINDOW HARDWARE

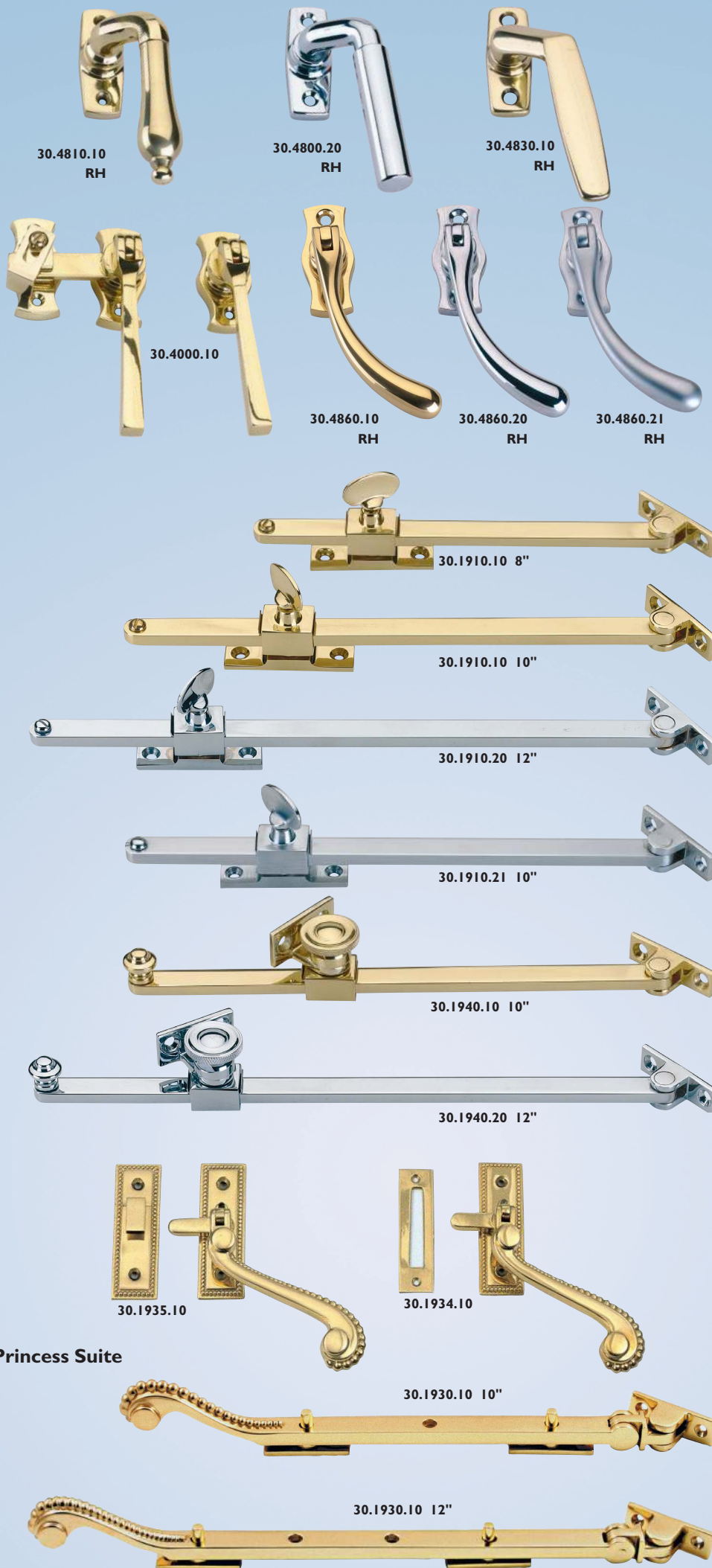

Princess Suite

CASEMENT WINDOW FITTINGS		
30.1910.10	Stay, 8, 10, 12"	PB
30.1910.20	Stay, 8, 10, 12"	CP
30.1910.21	Stay, 8, 10, 12"	SCP
<hr/>		
30.1930.10	Stay, 10, 12"	PB
30.1934.10	Fastener	
	Mortise Plate	PB
30.1935.10	Fastener Hook Plate	PB
<hr/>		
30.1940.10	Inward-Opening Stay, 10, 12"	PB
30.1940.20	Inward-Opening Stay, 10, 12"	CP
30.1940.21	Inward-Opening Stay, 10, 12"	SCP
<hr/>		
MISCELLANEOUS		
30.4000.10	French Window Fastener	PB
30.4000.20	French Window Fastener	CP
★ 30.4800.20	Espagnolette Handle LH or RH, 8mm	CP
★ 30.4810.10	Espagnolette Handle LH or RH, 8mm	PB
★ 30.4830.10	Espagnolette Handle LH or RH, 8mm	PB
★ 30.4860.10	Espagnolette Handle LH or RH, 7mm	PB
★ 30.4860.20	Espagnolette Handle LH or RH, 7mm	CP
★ 30.4860.21	Espagnolette Handle LH or RH, 7mm	SCP

★ For use with Mortise Espagnolette Bolts

FOR FURTHER INFORMATION ON FINISH DETAILS SEE PAGE I

WINDOW HARDWARE

SASH WINDOW FASTENERS

30.3010.10	Fitch	PB
30.3010.20	Fitch	CP
30.3010.21	Fitch	SCP
30.3010.41	Fitch	SNP
30.3010.53	Fitch	IBMA
30.3020.10	Reed Knob 70mm	PB
30.3020.20	Reed Knob 70mm	CP
30.3020.21	Reed Knob 70mm	SCP
30.3030.10	Brighton	PB
30.3030.20	Brighton	CP
30.3030.21	Brighton	SCP
30.3040.10	Plain Knob 70mm	PB
30.3040.20	Plain Knob 70mm	CP
30.3040.21	Plain Knob 70mm	SCP
30.3050.10	Claw 64mm	PB
30.3050.20	Claw 64mm	CP
30.3050.53	Claw 64mm	IBMA
30.3060.10	Cast 67mm	PB
30.3060.20	Cast 67mm	CP
30.3080.10	Heavy 76mm	PB
30.3080.20	Heavy 76mm	CP
30.3080.21	Heavy 76mm	SCP
30.3090.80	Zinc Brighton	EBP
30.3090.81	Zinc Brighton	BZP
30.3120.10	Cast 70mm	PB
30.3130.10	Cast Brighton	PB
30.3130.20	Cast Brighton	CP
30.3130.21	Cast Brighton	SCP
30.3140.10	China Knob 75mm	PB
30.3170.10	Plain Knob 70mm	PB
30.3170.20	Plain Knob 70mm	CP
30.3170.21	Plain Knob 70mm	SCP



30.3090.80

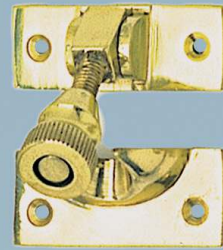

30.3130.10

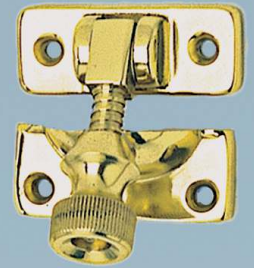

30.3030.10



30.3140.10

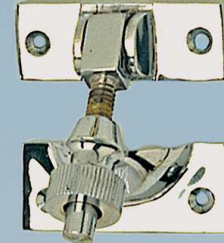

30.3130.20



30.3030.21



30.3170.21



30.3170.10



30.3170.20



30.3080.10

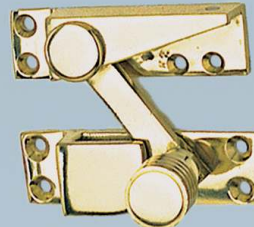

30.3120.10



30.3060.10



30.3020.21



30.3040.10

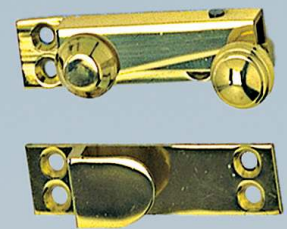

30.3020.10



30.3010.20



30.3010.10



30.3050.10

WINDOW HARDWARE



SASH LIFTS

30.3200.10	Heavy Cast, 50mm	PB
30.3214.10	Coach Line, 50mm	PB
30.3214.20	Coach Line, 50mm	CP
30.3220.10	Forged, 50mm	PB
30.3220.20	Forged, 50mm	CP
30.3220.21	Forged, 50mm	SCP
30.3220.41	Forged, 50mm	SNP
30.3220.53	Forged, 50mm	IBMA
30.3230.10	Std.Cast, 50mm	PB
30.3230.20	Std.Cast, 50mm	CP
30.3230.21	Std.Cast, 50mm	SCP
30.3233.10	Pressed, 50mm	PB
30.3233.20	Pressed, 50mm	CP
30.3233.21	Pressed, 50mm	SCP
30.3233.40	Pressed, 50mm	NP
30.3233.41	Pressed, 50mm	SNP
30.3233.53	Pressed, 50mm	IBMA
30.3235.10	Ring, 50mm	PB
30.3235.20	Ring, 50mm	CP
30.3235.21	Ring, 50mm	SCP
30.3240.10	Cast, 50, 75mm	PB
30.3240.20	Cast, 50, 75mm	CP
30.3250.10	Extruded, 65, 75mm	PB
30.3250.20	Extruded, 65, 75mm	CP
30.3250.21	Extruded, 65, 75mm	SCP
30.3270.55	Aluminium, 50mm	SAA

SASH HANDLES

30.3290.10	100, 125, 150mm	PB
30.3290.20	125, 150mm	CP
30.3290.21	125, 150mm	SCP
30.3298.82	Iron, 150mm	BJP

SASH FITTINGS

30.3320.10	Sash Pivot 65mm	PB
30.3325.10	Bartholomews Sash Stop	PB
30.3330.10	Acorn Sash Stop with Chain	PB
30.3330.20	(as above)	CP
30.3330.21	(as above)	SCP
30.3350.10	Screw Pulley, 1"	PB
30.3355.10	Single Knot Holder	PB
30.3371.00	Sash Pull DarkWood S/COL	
30.3372.00	Sash Pull LightWood S/COL	
30.3380.11	Sash Pulley, Wheel Ø 44, 50, 57mm	SAB
30.3380.20	Sash Pulley, Wheel Ø 44mm	CP

WINDOW HARDWARE

FRICTION STAYS

30.1960.10	Forto, 286mm	PB
30.1960.20	Forto, 286mm	CP
30.1960.21	Forto, 286mm	SCP
30.1970.10	Brass, 180°	PB
30.1970.85	Steel, 180°	SE

FANLIGHT WINDOW FITTINGS

30.2010.10	Catch, 2"	PB
30.2010.20	Catch, 2"	CP
30.2010.21	Catch, 2"	SCP
30.2020.10	Catch with Plate	PB
30.2020.20	Catch with Plate	CP
30.2020.21	Catch with Plate	SCP
30.2025.55	Catch, Aluminium, 55mm	SAA
30.2030.10	Quadrant Stay, 6, 8"	PB
30.2030.20	Quadrant Stay, 6, 8"	CP
30.2030.21	Quadrant Stay, 6, 8"	SCP
30.2040.10	Roller Stay, 8"	PB
30.2040.20	Roller Stay, 8"	CP
30.2040.21	Roller Stay, 8"	SCP
30.2050.10	Quadilent Stay, 5, 7, 9"	PB
30.2050.20	Quadilent Stay, 5, 7, 9"	CP
30.2050.21	Quadilent Stay, 5, 7, 9"	SCP
30.2050.82	Quadilent Stay, Iron, 5, 7"	BJP

WINDOW OPENERS

30.2085.81	Allway, 6"	BZP
30.2095.10	Skylux, 6", 12", 18"	PB
30.2095.20	Skylux, 6", 12"	CP
30.2095.21	Skylux, 6", 12"	SCP
30.2098.10	Deluxe Handle, 4, 5, 6, 7, 8' (Feet)	PB
30.2098.20	Deluxe Handle, 4, 5, 6, 7, 8' (Feet)	CP

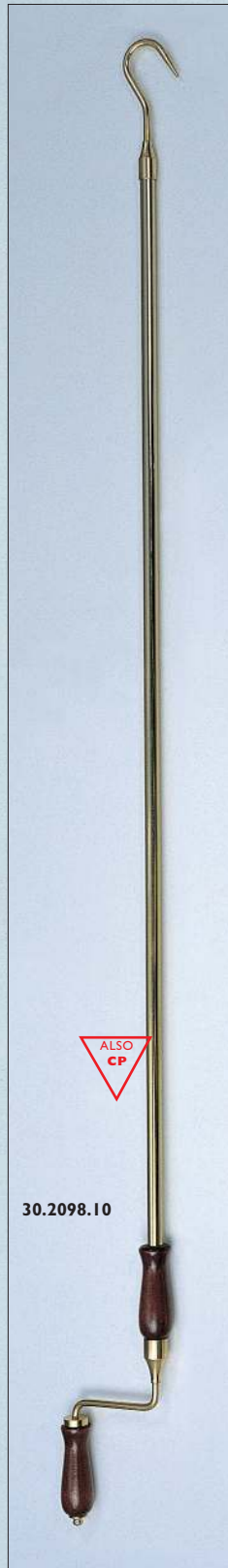

30.2098.10



30.2095.10



30.2095.20



30.2085.81



30.1970.10



30.2025.55



30.2010.10



30.2010.20



30.2020.10



30.1960.10



30.2050.82



30.2050.10

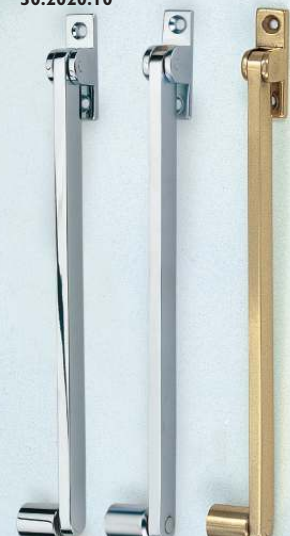

30.2040.20

30.2040.21

30.2040.10



30.2030.10

DOOR STOPS & DOOR HOLDERS



32.060.60	Rubber, 30, 35mm	VH
32.060.62	Rubber, 30, 35mm	BLACK
32.100.10	35, 45mm	PB
32.100.20	35, 45mm	CP
32.100.55	Aluminium, 45mm	SAA
32.104.10	Square, 45x28mm	PB
	Also CP, SCP & SNP	
32.105.10	Conical, 25x50mm	PB
	Also CP, SCP & SNP	
32.107.10	35x25, 45x28mm	PB
	Also CP, SCP & SNP	
32.108.10	32x35mm	PB
	Also CP, SCP & SAA	
32.120.10	Oval	PB
	Also CP, SCP, SNP & SAA	
32.130.10	Raised, Oval	PB
32.130.20	Raised, Oval	CP
32.130.21	Raised, Oval	SCP
32.140.10	85mm, Heavy	PB
	Also CP, SCP, SNP & IBMA	
32.144.10	115mm, Long	PB
32.144.20	115mm, Long	CP
32.144.21	115mm, Long	SCP
32.148.10	75mm, Light	PB
32.148.20	75mm, Light	CP
32.148.21	75mm, Light	SCP
32.150.10	65, 75mm, Sq Base	PB
32.150.20	65, 75mm, Sq Base	CP
32.150.21	65, 75mm, Sq Base	SCP
32.160.80	Steel, Flexible	EBP
32.160.81	Steel, Flexible	BZP
32.170.10	65, 75mm, Conceal-Fix	PB
	Also CP & SCP	
32.180.10	65, 75mm, Brass, C-Fix	PB
32.180.55	65, 75mm, Alum, C-Fix	SAA
32.184.10	115mm, Conceal-Fix	PB
32.222.20	Holder,	CP
32.222.21	Holder,	SCP
32.222.80	Holder,	EBP
32.235.10	Holder, 165mm	PB
32.240.10	Bayonet Catch	PB
32.240.20	Bayonet Catch	CP
32.240.21	Bayonet Catch	SCP
32.244.10	Double Beak Catch	PB
32.248.10	Beak & Ring Catch	PB
32.250.10	Magnetic Holder, 54mm	PB
32.250.20	Magnetic Holder, 54mm	CP
32.250.21	Magnetic Holder, 54mm	SCP
32.288.51	Door Porter, 23kg	80mm SSS



HOOKS

33.100.10	38, 50mm	PB
33.100.21	44mm	SCP
33.108.82	Iron, 50mm	BJP
33.110.10	50mm	PB
33.115.10	Maple Leaf	PB
33.120.10	Brass, Strip	PB
33.170.55	Alum, Extruded	SAA
33.175.55	Alum, Strip	SAA
33.180.20	Zinc Die-Cast	CP
33.205.21	50mm, Cast	SCP
33.220.10	50mm, Cast	PB
33.225.10	60mm, Forged	PB
	Also CP & SCP	
33.280.20	Zinc Die-Cast	CP
33.305.20	120mm Light Cast	CP
33.305.21	120mm Light Cast	SCP
33.306.10	120mm Medium Cast	PB
33.310.10	145mm Heavy	PB
33.310.20	145mm Heavy	CP
33.315.10	150mm Snub-Top	PB
33.315.20	150mm Snub-Top	CP
33.318.82	150mm Iron	BJP
33.320.10	Brass, Strip	PB
33.335.10	Ball End	PB
33.335.20	Ball End	CP
33.340.10	Sq Base Heavy	PB
33.345.10	Bead Edge	PB
33.355.10	Rope Edge	PB
33.370.55	Alum, Extruded	SAA
33.375.55	Alum, Strip	SAA
33.380.10	Multiple Hook	PB
	Also in CP & SCP	
33.390.10	Bumper Hook	PB
	Also in CP & SCP	
33.395.10	Princess Hook	PB
33.4010.20	80mm	CP
33.4010.22	80mm	MC/CP
33.4010.41	80mm	MNK
33.4020.20	160mm	CP
33.4020.22	160mm	MC/CP
33.4020.41	160mm	MNK
33.4060.41	50mm, 70mm	MNK
33.433.10	Folding Hook	PB
33.433.20	Folding Hook	CP

MISCELLANEOUS HOOKS

33.600.00	25, 38, 60mm	S/COL
33.602.00	20, 28, 40mm	S/COL
33.605.00	20, 25, 30, 35mm	S/COL
33.612.80	25, 38, 60mm	EBP
33.615.00	25, 38, 50mm	S/COL
33.618.10	Side Hooks, 50mm	PB
33.620.80	Single Hook No 1, 2	
	Double Hook No 3	EBP

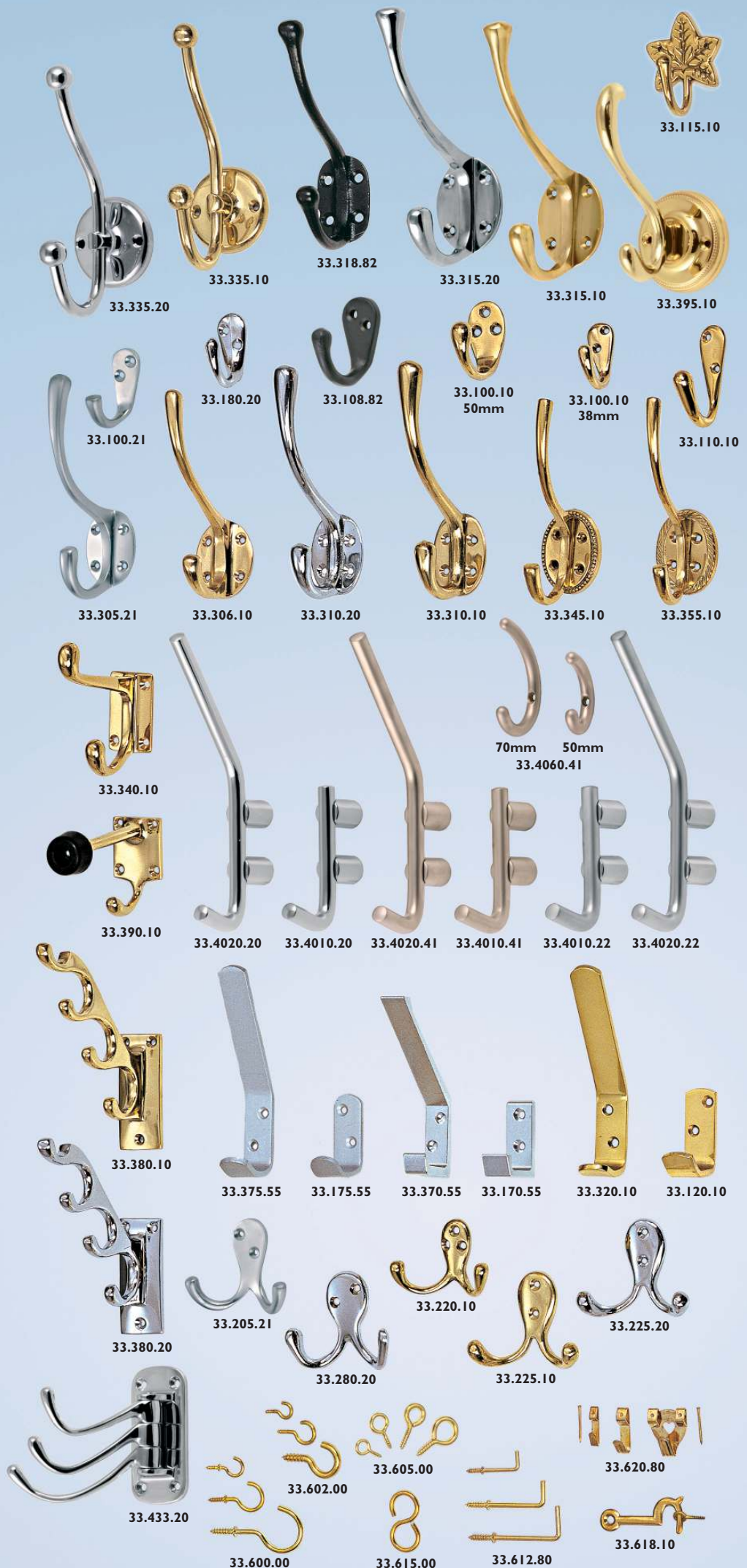

HOOKS



33.010.10	Stud Hook, 32mm	PB
	Also CP & MNK	
33.012.20	Stud Hook, 33mm	CP
33.012.21	Stud Hook, 33mm	SCP
33.014.20	Stud Hook, 45mm	CP
33.014.21	Stud Hook, 45mm	SCP
33.030.20	Stud Hook, 42mm	CP
33.030.21	Stud Hook, 42mm	SCP
33.034.20	Stud Hook, 45mm	CP
33.034.21	Stud Hook, 45mm	SCP
33.4030.10	Stud Hook, 32mm	PB
	Also CP & MNK	
33.414.10	Cleat, 65, 75, 100mm	PB
	Also CP & SCP	
33.420.10	Hanger Support	PB
33.420.20	Hanger Support	CP
33.4234.03	55, 75mm	ANTBTR
33.4234.10	35, 55mm	PB
33.445.10	3 Hooks, 160x42mm	
	5 Hooks, 230x45mm	PB
TASSEL HOOKS		
33.500.10	65mm	PB
33.510.10	50mm	PB
33.540.20	40, 50mm, Zinc	CP
33.540.21	40, 50mm, Zinc	SCP
33.550.10	35, 40, 50mm, Brass	PB
33.550.20	35, 40, 50mm, Brass	CP
33.580.10	Tapestry Hook, 19mm	PB
33.624.10	Picture Hook, 60mm	PB
33.625.10	Pipe Hook, 19, 25mm	PB
33.630.10	Moulding Rail Hook	PB
33.630.20	Moulding Rail Hook	CP
33.650.10	Pole Hook 25mm ø	PB
33.650.20	Pole Hook 25mm ø	CP
33.655.10	Pole Hook Holder	PB
33.660.10	Rope Hook 32mm	PB
33.665.10	Eye Plate	PB
CABIN HOOKS		
33.840.82	Iron, 150, 200, 300, 400, 450mm	BJP
33.860.10	Silent, 100, 150, 200mm	PB
	Also CP & SCP	
33.880.10	50, 75, 100, 150mm	PB
33.880.20	150mm	CP
33.885.10	Medium 100, 150, 200mm	PB
	Also CP & SCP	
33.888.10	Strong, 200, 250, 300mm	PB
	Also CP & SCP	
CEILING HOOKS		
33.900.10	75mm	PB
33.904.10	100mm	PB
	Also CP & SCP	
33.906.10	150mm	PB
	Also CP & SCP	
33.925.10	65mm	PB

HINGES

Unwashed Brass Butt Hinges Height x Open Width

35.100.00	50x28, 65x35, 75x41, 100x60mm	S/COL
35.100.10	38x23, 50x28, 65x35, 75x41, 100x60mm	PB
35.100.20	38x23, 50x28, 65x35, 75x41, 100x60mm	CP
35.100.21	38x23, 50x28, 65x35, 75x41, 100x60mm	SCP
35.100.53	50x28, 65x35, 75x41mm	IBMA

35.140.00	75x50, 100x66, 100x75mm	S/COL
35.140.10	75x50, 100x66, 100x75mm	PB
35.140.20	75x50, 100x66, 100x75mm	CP
35.140.21	75x50, 100x66, 100x75mm	SCP

PARLIAMENT HINGES

35.150.10	4x4", 4x5", 4x6"	PB
35.150.20	4x4", 4x5", 4x6"	CP
35.150.21	4x4", 4x5", 4x6"	SCP

PROJECTION HINGES

35.160.00	76x76mm, 100x100mm	S/COL
35.160.10	(as above)	PB
35.160.20	(as above)	CP
35.160.21	(as above)	SCP

35.175.10	Ball-Tip Finial Hinge 51x29, 64x35mm	PB
-----------	---	----

RISING HINGES

35.190.10	Brass, LH or RH 100x66mm	PB
35.190.55	Aluminium, LH or RH 100x66mm	SAA

35.195.00	Stormproof Hinge, 65mm	S/COL
-----------	---------------------------	-------

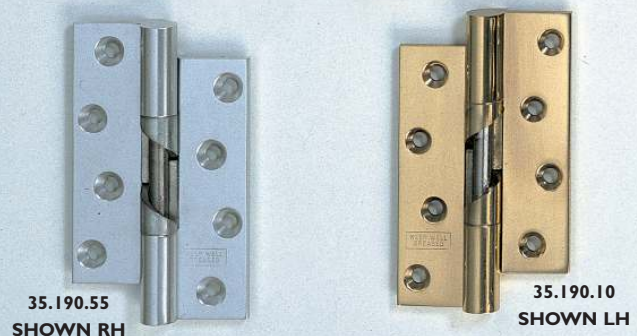
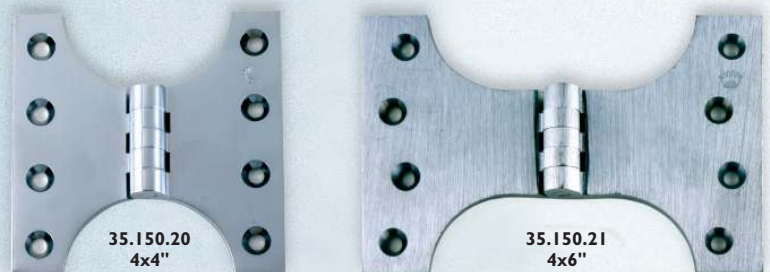
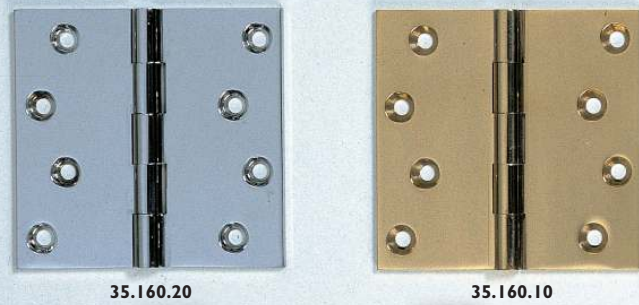
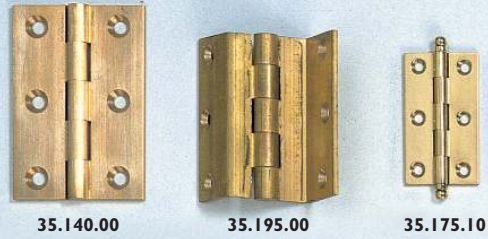
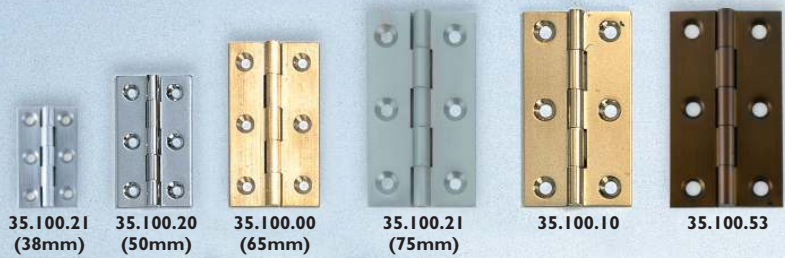

HINGES



35.210.20
102x76mm



35.210.21
102x66mm



35.210.21
76x51mm



35.220.10
152x102mm



35.220.10
102x76mm



35.220.20
102x66mm



35.220.10
76x51mm



35.258.10
102x102mm



35.258.10
102x76mm



35.258.10
76x51mm



35.248.53
100x75mm



35.230.10
4x5"



35.230.10
4x6"



35.230.20
4x4"



35.230.21
4x8"



35.2950.10
100x100mm



35.290.10
102x76mm

Washed Brass Butt Hinges Height x Open Width

35.210.20	DPBW, 76x51, 102x66, 102x76mm	CP
35.210.21	DPBW, 76x51, 102x66, 102x76mm	SCP
35.220.10	DPBW, 76x51, 102x66, 102x76, 152x102mm	PB
35.220.20	DSSW, 76x51, 102x66, 102x76mm	CP
35.230.10	DPBW Projection, 4x4", 4x5", 4x6", 4x8"	PB
35.230.20	DPBW Projection, 4x4", 4x5", 4x6", 4x8"	CP
35.230.21	DPBW Projection, 4x4", 4x5", 4x6", 4x8"	SCP
35.248.53	DPBW, 75x50, 100x75mm	IBMA
35.258.10	Ball-Bearing Washers 76x51, 102x76, 102x102mm	PB
35.290.10	Brass Finial Hinge, DPBW, 76x51, 102x66, 102x76mm	PB
35.2950.10	Brass Finial Hinge, Ball-Race, 100x75, 100x100, 125x75mm	PB

DSSW: Double Stainless-Steel Washered
DPBW: Double Phosphor-Bronze Washered

HINGES

35.300.10	32x48, 38x60, 50x76mm	PB
35.310.00	Brass Lift-Off 76x41mm, LH or RH	S/COL
35.315.10	Strap Hinge, 50mm	PB
35.330.10	Counterflap, 25x76, 32x102, 38x114mm	PB
35.330.20	Counterflap, 32x102mm	CP
35.335.00	Card Table Hinge, 65mm	S/COL
35.340.00	Centre Pivot Hinge, 13x64mm	S/COL
35.355.00	Screen Hinge, 25x50mm	S/COL
35.372.10	Snake Hinge, 75mm	PB
35.375.10	Brass 'H' Hinge, 75mm	PB
35.380.10	Brass Angle Hinge, 51x19x22x17mm 64x19x22x17mm 64x19x25x21mm 102x41x46x37mm	PB
35.430.10	Lift-Off Finial Hinge, 60mm, LH or RH	PB
35.460.10	Angle Hinge, 40mm	PB
35.460.40	Angle Hinge, 40mm	NP
35.482.80	Glass Door Hinge, Die-Cast, Zinc	EBP
35.501.40	Blum Hinge, 90°	NP
35.511.40	Blum Hinge, 170°	NP
35.515.40	Cruciform Plate	NP
Brass PIANO HINGES 72" Long		
35.550.10	20G, 1, 1 1/4, 1 1/2", Open	PB
35.550.20	20G, 1, 1 1/4, 1 1/2", Open	CP
35.555.10	18G, 2", Open	PB
35.555.20	18G, 2", Open	CP
35.570.80	20G, 1, 1 1/4, 1 1/2", Open Steel Piano Hinge	EBP
SOSS HINGES DIE CAST ZINC		
35.6201.80	1 3/4" x 3/8"	EBP
35.6203.80	1 3/4" x 1/2"	EBP
★ 35.6204.80	2 3/8" x 1/2"	EBP
★ 35.6208.80	2 3/4" x 5/8"	EBP
★ 35.6212.80	3 3/4" x 3/4"	EBP
★ 35.6216.80	4 5/8" x 1"	EBP
★ 35.6218.80	4 5/8" x 1 1/8"	EBP
35.6220.80	5 1/2" x 1 3/8"	EBP
35.700.20	Steel Flush Hinge 50, 60, 75mm	CP
35.700.80	Steel Flush Hinge 50, 60, 75mm	EBP

★ also available in Nickel-Plated Finish

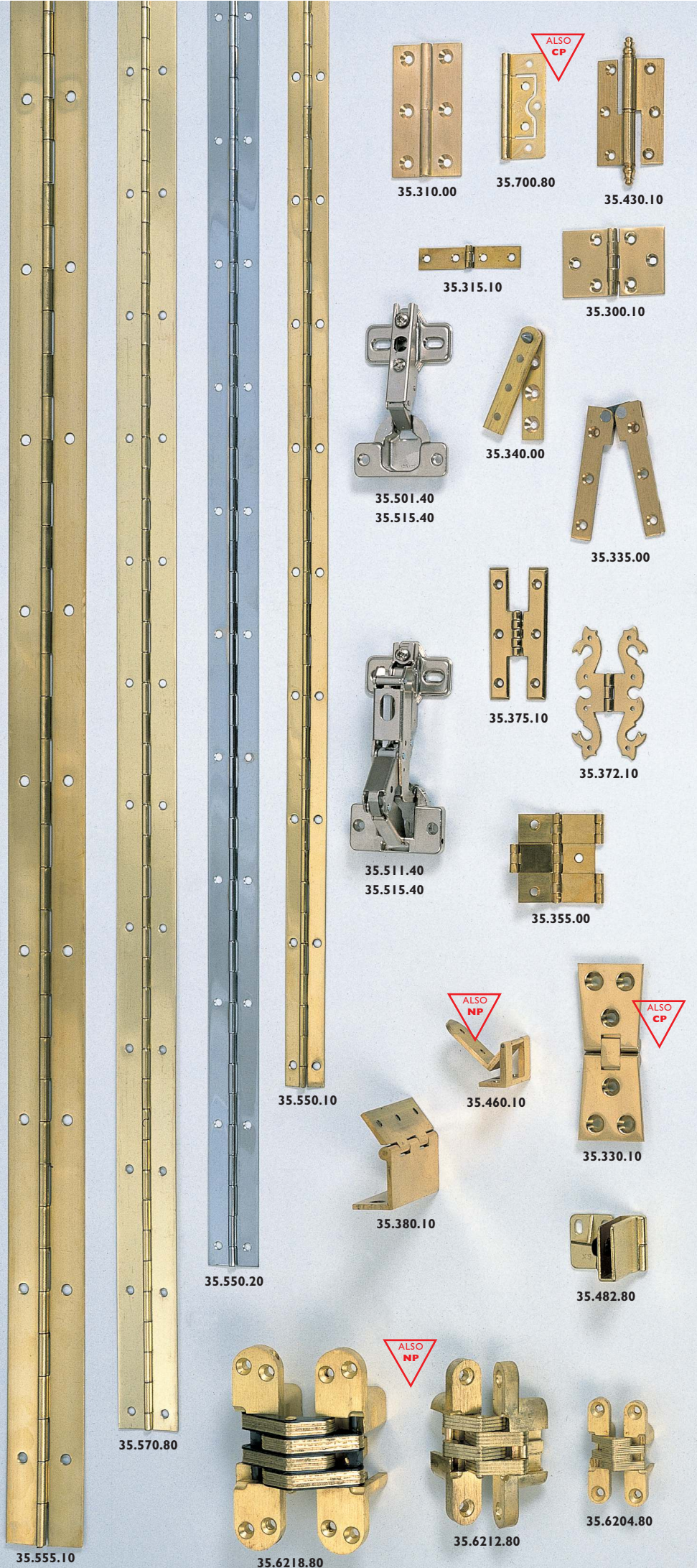

DANICO

020 7483 4477

HINGES



35.820.80



35.820.50
76x50mm



35.820.50
102x76mm



35.820.50
102x102mm



35.890.50 LH



35.820.51
76x50mm



35.820.51
102x76mm



35.820.51
102x102mm



35.760.00

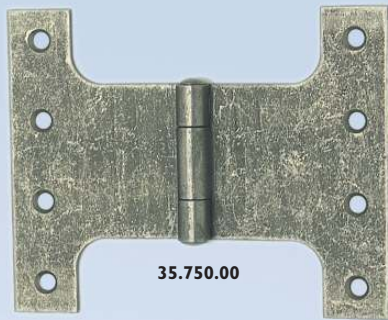

35.750.00

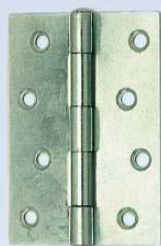

35.710.81

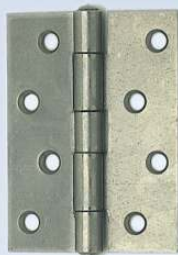

35.720.00



35.740.00



35.840.55



35.850.55



35.790.80 RH



35.940.10



35.930.85

35.710.00	Steel Butt 65, 75, 100mm	S/COL
35.710.81	Steel Butt 65, 75, 100mm	BZP
35.720.00	Strong Steel Butt 75, 100mm	S/COL
35.740.00	Cast Iron Butt 65, 75, 100mm	S/COL
35.750.00	Parliament, 5x6"	S/COL
35.760.00	Reversible Gate, 12, 16, 24, 30"	S/COL
35.770.82	Steel Tee 6, 12, 18"	BJP
35.790.00	Steel Rising, LH or RH, 100mm	S/COL
35.790.80	(as above)	EBP
35.790.81	(as above)	BZP
35.820.50	Stainless Steel, 2 Ball Race, 75x50, 102x75, 102x102mm	PSS
35.820.51	(as above)	SSS
35.820.80	102x75mm S/Steel	EBP
35.840.55	Aluminium, DSSW 75x50, 100x66, 100x75mm	SAA
35.850.55	Aluminium, SSW 76x51, 102x70mm	SAA
35.890.50	Stainless Steel Rising LH or RH, 102x75mm	PSS
35.890.51	(as above)	SSS
SPRING HINGES – DOUBLE ACTION		
35.930.85	Steel, 4", 5", 6"	SE
35.940.10	Brass, 3", 4", 5", 6"	PB
35.940.80	Steel, 3", 4", 5", 6"	EBP

FOR FURTHER INFORMATION
ON FINISH DETAILS SEE PAGE 1

BOLTS

STANDARD BARREL BOLTS

36.100.10	25mm Wide, 38, 50, 65, 75, 100, 150mm	PB
36.100.20	25mm Wide, 50, 65, 75, 100, 150mm	CP
36.105.10	25mm Wide, Necked, 75, 100, 150mm	PB
36.105.20	25mm Wide, Necked, 75, 100, 150mm	CP
36.140.10	30mm Wide, 150, 200, 300mm	PB
36.140.20	30mm Wide,(as above)	CP
36.145.10	30mm Wide, Necked, 150mm	PB
36.145.20	30mm Wide, Necked, 150mm	CP
36.150.10	38mm Wide, 150, 200, 300mm	PB
36.150.21	150, 200mm	SCP
36.180.10	30mm Wide, Shaped Bolt 75, 100, 150mm	PB
36.185.10	75, 100, 150mm, Nkd	PB

SUPERIOR BARREL BOLT

36.200.10	28mm Wide, 75, 100, 150mm	PB
36.200.20	28mm Wide, 75, 100, 150mm	CP
36.200.21	28mm Wide, 75, 100, 150mm	SCP
36.205.10	28mm Wide, Necked, 100, 150mm	PB
36.205.20	28mm Wide, Necked, 100, 150mm	CP
36.205.21	28mm Wide, Necked, 100, 150mm	SCP
36.220.10	32mm Wide, 200, 300, 450, 600mm	PB
36.220.20	(as above)	CP
36.220.21	(as above)	SCP
36.240.10	35mm Wide, 150, 200, 250mm	PB
36.240.20	35mm Wide, 150, 200, 250mm	CP
36.240.21	35mm Wide, 150, 200, 250mm	SCP



BOLTS & DOOR-CHAINS

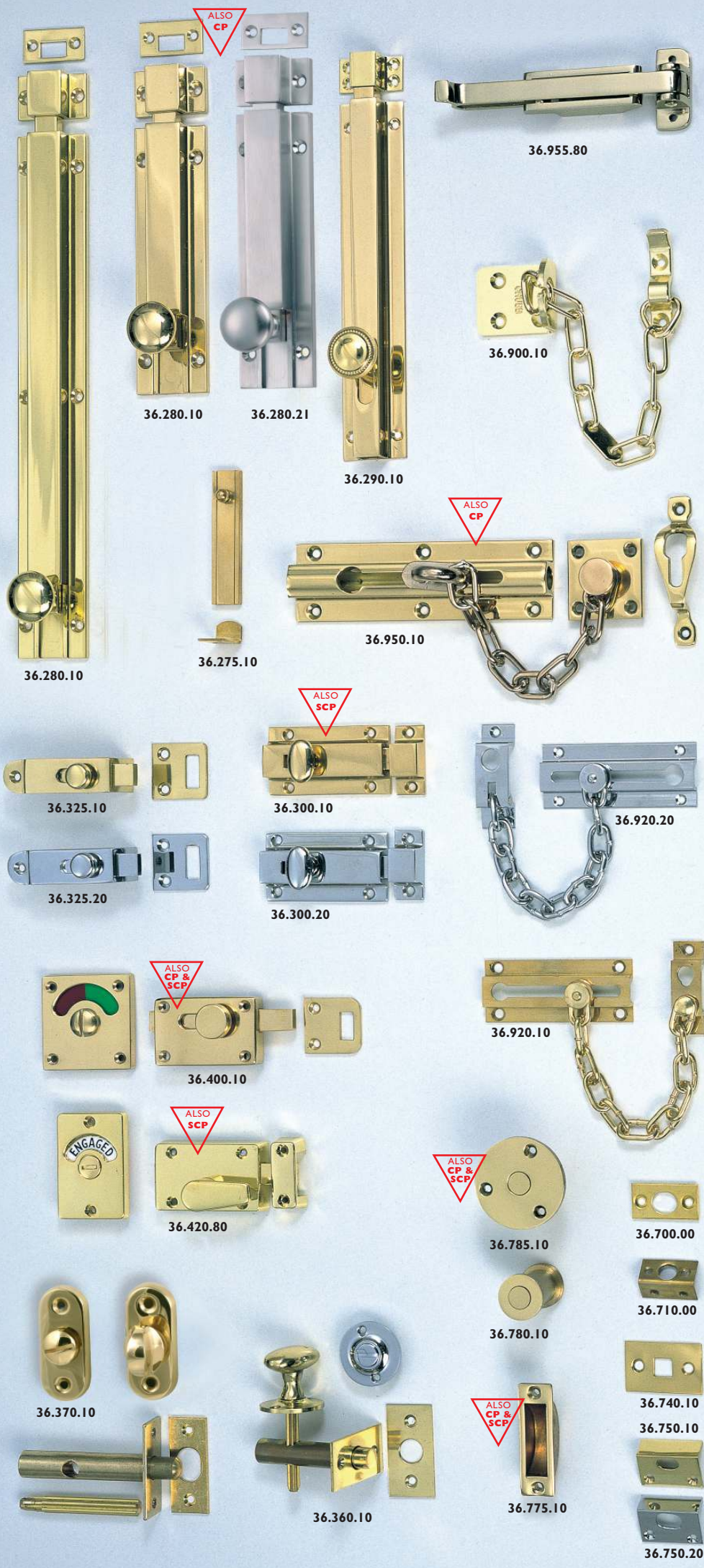

36.275.10	16x75mm	PB
36.280.10	41mm Wide, 150, 200, 305mm	PB
36.280.20	(as above)	CP
36.280.21	(as above)	SCP
36.290.10	38mm Wide, 150, 200, 300mm	PB
36.300.10	35mm Wide, 75mm	PB
36.300.20	35mm Wide, 75mm	CP
36.300.21	35mm Wide, 75mm	SCP
36.325.10	70mm	PB
36.325.20	70mm	CP
36.325.21	70mm	SCP
36.360.10	Rack Bolt with Release Backset 40mm	PB
36.360.20	(as above)	CP
36.370.10	Rack Bolt with Release Backset 60mm	PB

INDICATING BOLTS WITH RELEASE

36.400.10	Indicating Bolt, Brass	PB
36.400.20	Indicating Bolt, Brass	CP
36.400.21	Indicating Bolt, Brass	SCP
36.420.21	Indicating Bolt, Zinc	SCP
36.420.80	Indicating Bolt, Zinc	EBP

KEEP PLATES

36.700.00	Flat, 8, 10, 12mm	S/COL
36.710.00	Angle, 8mm	S/COL
36.740.10	28x44x10mm	PB
36.750.10	Angle, 8, 10, 12mm	PB
36.750.20	Angle, 8, 10, 12mm	CP
36.750.21	Angle, 8, 10, 12mm	SCP

EASY CLEAN & DUST EXCLUDING SOCKETS

36.775.10	Easy Clean 12mm	PB
36.775.20	Easy Clean 12mm	CP
36.775.21	Easy Clean 12mm	SCP
36.780.10	Dust Excluding 12mm	PB
36.780.21	Dust Excluding 12mm	SCP
36.785.10	Dust Excluding 12mm	PB
36.785.21	Dust Excluding 12mm	SCP

DOOR CHAINS

36.900.10		PB
36.900.21		SCP
36.920.10	100mm	PB
36.920.20	100mm	CP
36.950.10	44x150mm	PB
36.950.20	44x150mm	CP
36.950.21	44x150mm	SCP
36.955.21	Door Limiter	SCP
36.955.80	Door Limiter	EBP

BOLTS

HALF-ROUND SECTION OPEN BOLTS

36.382.10	200, 300mm	PB
36.388.10	200, 300, 450, 600mm	PB

FLUSH BOLTS 3/4" WIDE

36.500.10	6", 8", 10", 12", 18", 24", 30", 36"	PB
36.500.20	(as above)	CP
36.500.21	(as above)	SCP
36.500.53	(as above)	IBMA

FLUSH BOLTS 1" WIDE

36.510.10	6", 8", 10", 12"	PB
36.510.20	(as above)	CP
36.510.21	(as above)	SCP

FLUSH BOLTS 3/4" WIDE, LONG SHOOT

36.530.10	8", 10", 12"	PB
36.530.20	8"	CP
36.530.21	8"	SCP

FLUSH BOLTS 1" WIDE WITH KNOB SLIDE

36.540.10	6", 9"	PB
36.540.20	6", 9"	CP
36.540.21	6", 9"	SCP

FLUSH BOLTS WITH THUMB SLIDE, FORGED.

36.550.10	3x 1/2", 4x 5/8", 6x 3/4"	PB
36.550.20	(as above)	CP
36.550.21	(as above)	SCP
36.560.10	With Thumb Slide, Cast 3x 1/2", 4x 5/8"	PB

IRON DOOR BOLTS

36.8000.82	Tower Bolt, 150, 200mm	BJP
36.8030.82	Monkey Tail 450mm	BJP
36.8110.82	38x100, 150mm	BJP
36.8130.82	150, 200mm	BJP
36.8152.82	100, 150mm Necked	BJP
36.8240.82	200, 250mm	BJP

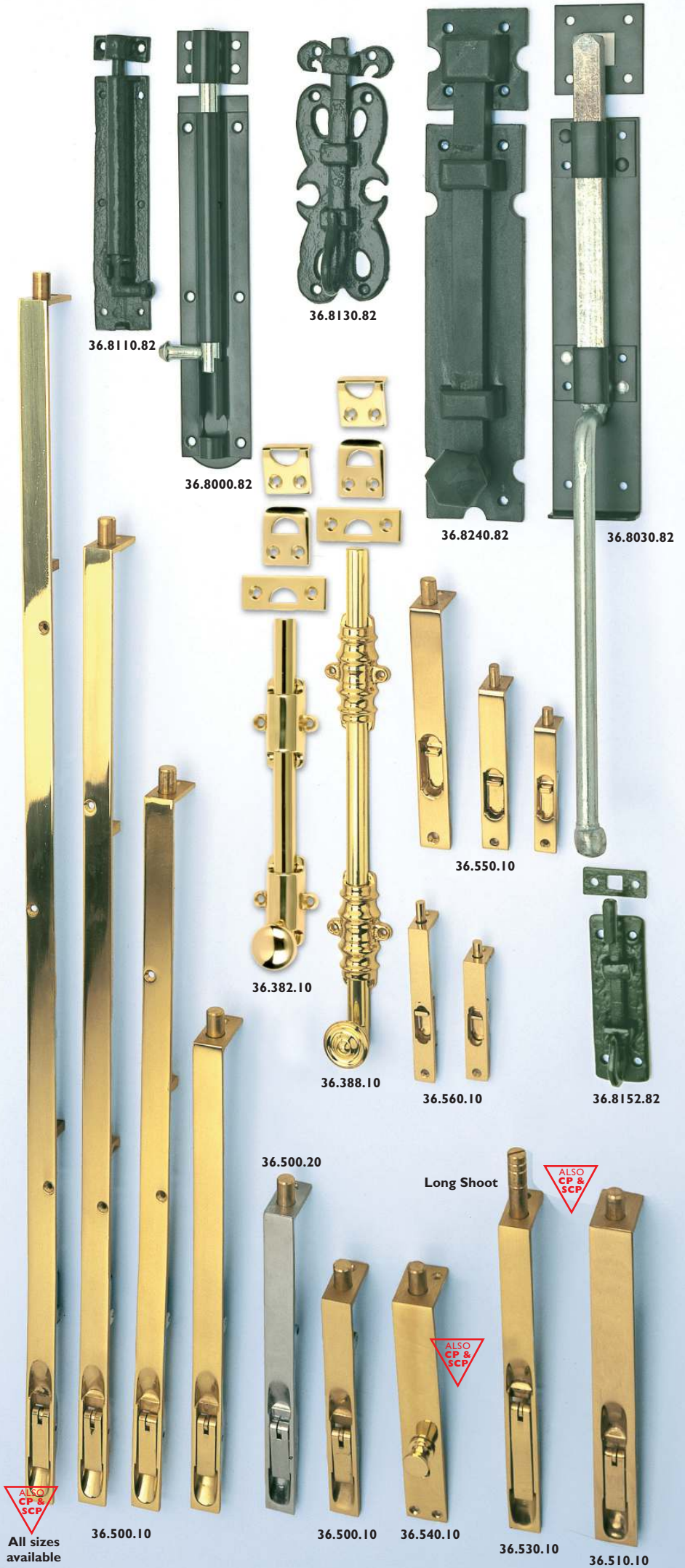

All sizes available

ESPAGNOLETTE BOLTS

ESPAGNOLETTE BOLTS

36.630.10	16mm Half-Round Shoots 96" Long	PB
36.630.20	(as above)	CP
36.630.21	(as above)	SCP
36.634.10	Locking Block	PB
36.634.20	Locking Block	CP
36.634.21	Locking Block	SCP
<hr/>		
36.650.10	14x8mm Shoots 84", 96" Long	PB
36.650.20	(as above)	CP
36.650.21	(as above)	SCP
<hr/>		
★ 36.660.10	13x6mm Shoots 84", 96" Long	PB
★ 36.660.20	(as above)	CP
★ 36.660.21	(as above)	SCP
★ 36.662.10	as 36.660.10, but with lever handle	PB
<hr/>		
★ 36.670.10	14x8mm Shoots, LH or RH 84", 96" Long, Locking	PB
★ 36.670.20	(as above)	CP
★ 36.670.21	(as above)	SCP
★ 36.672.10	as 36.670.10, Non-Locking LH or RH	PB
<hr/>		
36.690.10	10mm Sq Shoots 96" Long Princess Suite	PB

- ★ Outside Handles are available to allow operation from both sides.
Please ask for details

**LONGER LENGTHS ARE AVAILABLE,
PLEASE ASK FOR DETAILS**

DANICO

020 7483 4477

VENTS

VENTILATOR GRILLES

39.100 .10	Oval Hole, 6x3", 6x6", 9x1 1/2", 9x3", 9x6", 12x3", 12x12"	PB
39.100 .20	(as above)	CP
39.100 .51	(as above)	SSS
39.200 .10	Hit & Miss, 6x3", 6x6", 9x3", 9x6", 9x9", 12x3", 12x6", 12x9", 12x12"	PB
39.200 .20	(as above)	CP
39.200 .51	(as above)	SSS
39.300 .10	Louvre, 6x3", 6x6", 9x3", 9x6", 9x9", 12x3", 12x6", 12x9", 12x12", 25 1/2x2"	PB
39.300 .20	(as above)	CP
39.300 .51	(as above)	SSS
39.400 .10	Square Hole, 6x3", 6x6", 9x3", 9x6", 9x9", 12x3", 12x6", 12x9", 12x12"	PB
39.400 .20	(as above)	CP
39.400 .51	(as above)	SSS
39.500 .10	Circular, 3", 4", 5"	PB
39.500 .20	Circular, 3", 4", 5"	CP
39.500 .21	Circular, 3", 4", 5"	SCP
39.500 .51	Circular, 3", 4", 5"	SSS
39.600 .00	Alum, 165x90, 241x90, 241x165, 241x241, 305x152, 305x305mm	S/COL

Special sizes can be made to order

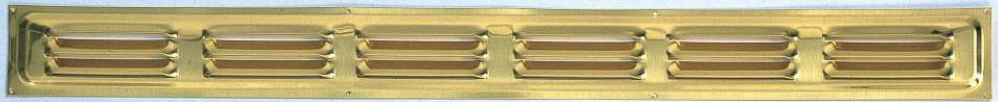

39.300.10

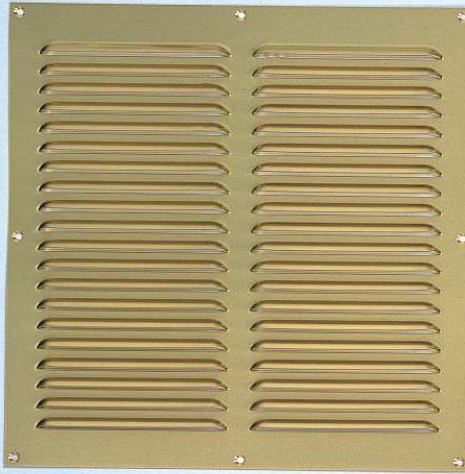

39.300.10

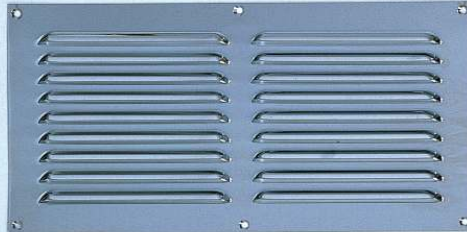

39.300.20

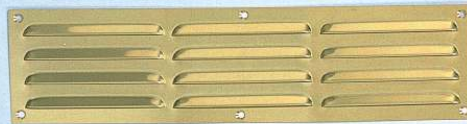

39.300.10

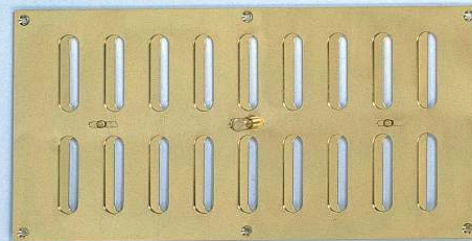

39.200.10

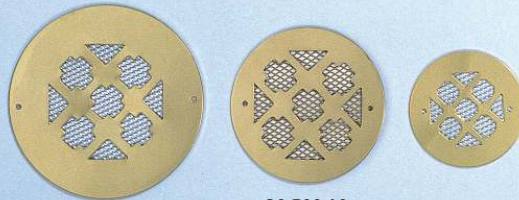

39.500.10

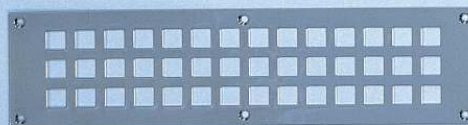

39.400.20

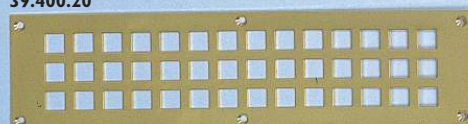

39.400.10

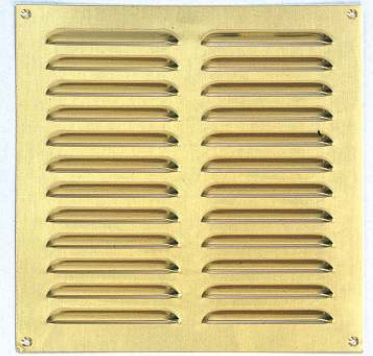

39.300.10

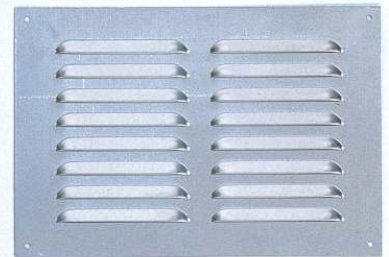

39.600.00



39.300.10



39.300.10

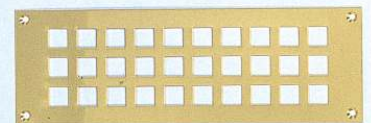

39.400.10

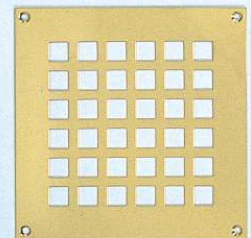

39.400.10



39.100.10

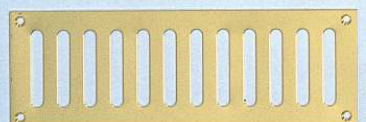

39.100.10

DOOR FURNITURE

LEVER HANDLES



JADO LEVER HANDLES



ESCUTCHEONS



RING FURNITURE



KNOB FURNITURE



FINGER PLATES



LEVER HANDLES

For matching escutcheons see pages 78 & 79

ROUND ROSE LEVER HANDLES

40.430.16	Ceramic Lever	
	Rose 55mm	PB/WH
40.740.10	15mm diameter	
	Rose 50mm	PB
40.740.20	15mm diameter	
	Rose 50mm	CP
40.740.21	15mm diameter	
	Rose 50mm	SCP
40.740.53	15mm diameter	
	Rose 50mm	IBMA
40.750.10	20mm diameter	
	Rose 52mm	PB
40.750.20	20mm diameter	
	Rose 52mm	CP
40.750.21	20mm diameter	
	Rose 52mm	SCP
40.750.55	19mm diameter Alum	
	Rose 52mm	SAA
40.755.10	17mm diameter	
	Rose 52mm	PB
40.755.20	17mm diameter	
	Rose 52mm	CP
40.755.21	17mm diameter	
	Rose 52mm	SCP
40.798.20	17mm diameter	
	Rose 52mm	CP
40.798.21	17mm diameter	
	Rose 52mm	SCP

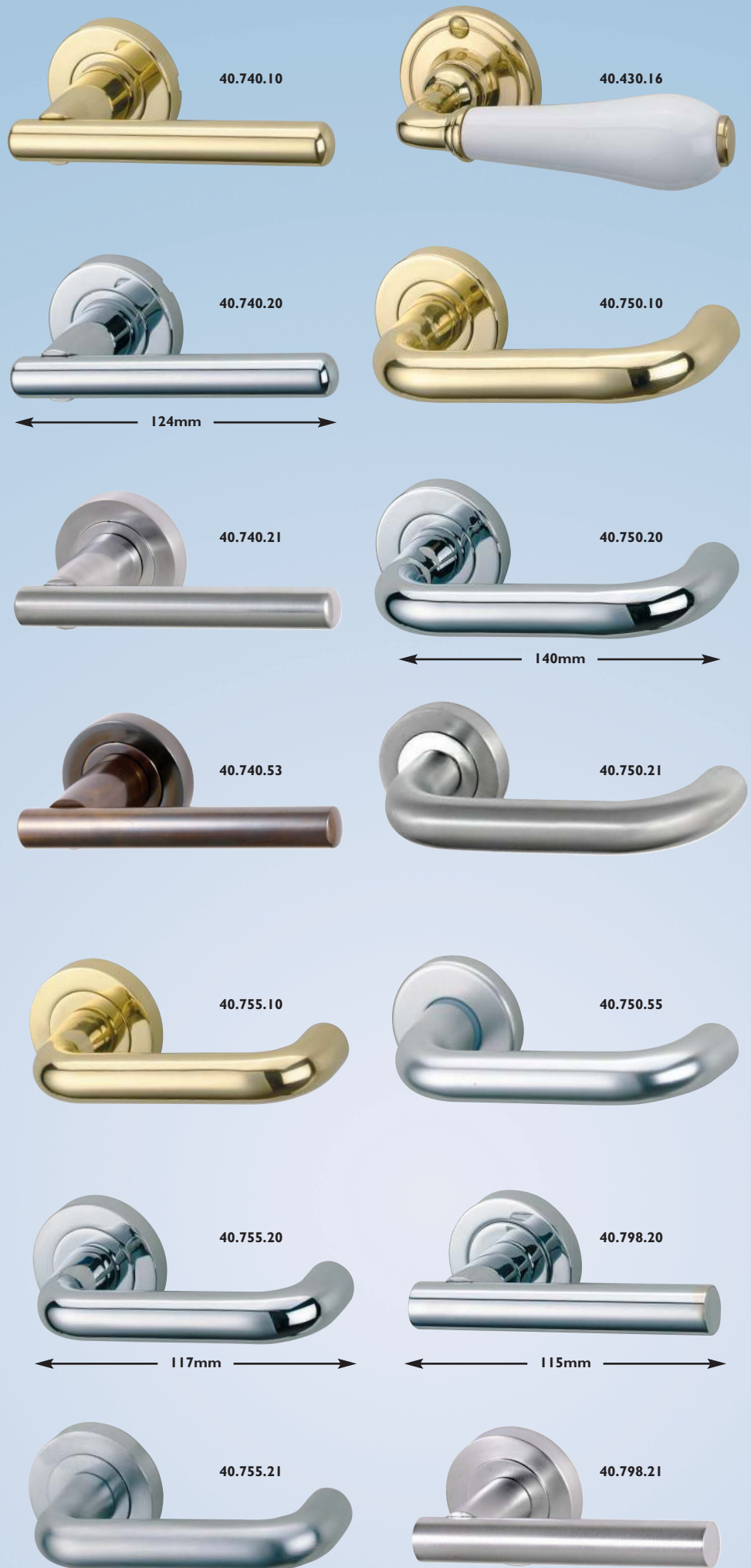

LEVER HANDLES

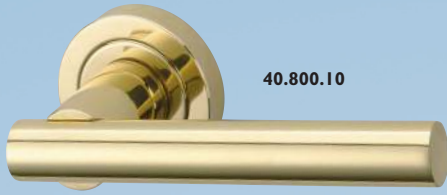

40.800.10



40.795.10

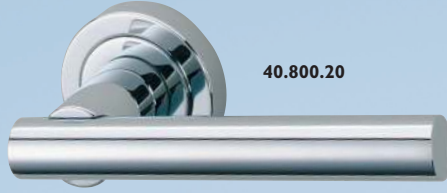

40.800.20



40.795.20

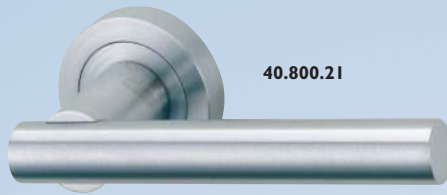

40.800.21



40.795.21

125mm

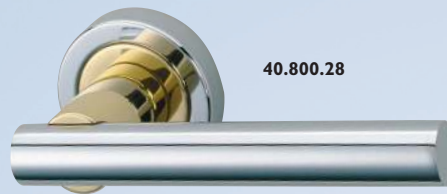

40.800.28

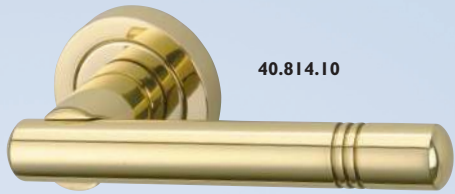

40.814.10



40.790.10



40.814.20

130mm



40.790.20



40.814.21



40.790.21



40.792.21

For matching Turn & Release see page 80 & 81

ROUND ROSE LEVER HANDLES

40.790.10	Rose 50mm	PB
40.790.20	Rose 50mm	CP
40.790.21	Rose 50mm	SCP

40.792.20	Rose 50mm	CP
40.792.21	Rose 50mm	SCP

40.795.10	Rose 50mm	PB
40.795.20	Rose 50mm	CP
40.795.21	Rose 50mm	SCP

40.800.10	17mm diameter	
	Rose 50mm	PB
40.800.20	17mm diameter	
	Rose 50mm	CP
40.800.21	17mm diameter	
	Rose 50mm	SCP
40.800.28	17mm diameter	
	Rose 50mm	PB/CP

40.814.10	17mm diameter	
	Rose 50mm	PB
40.814.20	17mm diameter	
	Rose 50mm	CP
40.814.21	17mm diameter	
	Rose 50mm	SCP



40.792.20

LEVER HANDLES

For matching escutcheons see pages 78 & 79

STAINLESS STEEL LEVER HANDLES

40.7128.51	Rose 52mm	SSS
40.7129.51	Rose 52mm	SSS
40.7130.51	Rose 52mm	SSS
40.7131.51	Rose 52mm	SSS
40.7132.51	Rose 52mm	SSS
	with Brown Leather Grip	
40.7133.52	Rose 52mm	SS/PS
40.7134.52	Rose 52mm	SS/PS
40.7137.52	Rose 52mm	SS/PS
40.7163.51	Rose 52mm	SSS
* 40.7164.51	Rose 52mm	SSS
40.7164.52	Rose 52mm	SS/PS
40.7165.52	Rose 52mm	SS/PS
40.7169.51	Rose 52mm	SSS
40.7172.51	Rose 52mm	SSS
40.7176.51	Rose 52mm	SSS

* Not Illustrated



40.7128.51



40.7130.51



40.7129.51



40.7172.51



40.7131.51



40.7163.51

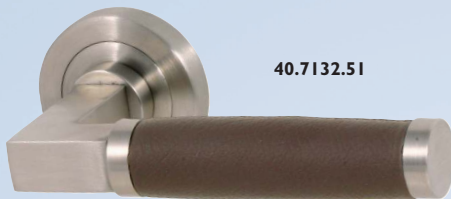

40.7132.51



40.7176.51



40.7134.52



40.7169.51



40.7137.52



40.7164.52



40.7133.52



40.7165.52

LEVER HANDLES



40.7226.10



40.7225.10



40.7226.20



40.7225.20



40.7226.41



40.7225.41



40.7227.20



40.7227.41



40.7228.10



40.7229.10



40.7228.20

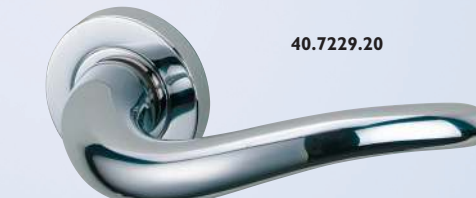

40.7229.20



40.7228.41



40.7229.41

For matching Turn & Release see page 80

ROUND ROSE LEVER HANDLES

40.7225.10	Rose 50mm	PB
40.7225.20	Rose 50mm	CP
40.7225.41	Rose 50mm	MNK

40.7226.10	Rose 50mm	PB
40.7226.20	Rose 50mm	CP
40.7226.41	Rose 50mm	MNK

40.7227.10	Rose 50mm	PB
40.7227.20	Rose 50mm	CP
40.7227.41	Rose 50mm	MNK

40.7228.10	Rose 50mm	PB
40.7228.20	Rose 50mm	CP
40.7228.41	Rose 50mm	MNK

40.7229.10	Rose 50mm	PB
40.7229.20	Rose 50mm	CP
40.7229.41	Rose 50mm	MNK



40.7227.10

LEVER HANDLES

ROUND ROSE LEVER HANDLES

40.817.20	15mm diameter	
	Rose 45mm	CP
40.817.21	15mm diameter	
	Rose 45mm	SCP
40.818.20	15mm diameter	
	Rose 45mm	CP
40.818.21	15mm diameter	
	Rose 45mm	SCP
40.8417.10	Rose 52mm	PB
40.8417.20	Rose 52mm	CP
40.8423.10	Rose 55mm	PB
40.8423.43	Rose 55mm	MN/CP
40.8426.10	Rose 52mm	PB
40.8426.20	Rose 50mm	CP
40.8427.12	Rose 65mm	PB/BK
40.8427.16	Rose 65mm	PB/WH
40.8439.10	Rose 50mm	PB
40.8439.41	Rose 55mm	MNK



40.8427.16



40.8427.12



40.8417.10

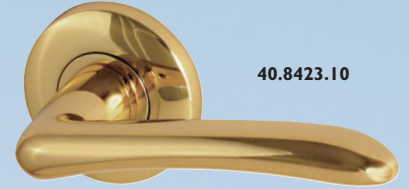

40.8423.10



40.8417.20



40.8423.43



40.8426.10



40.8439.10

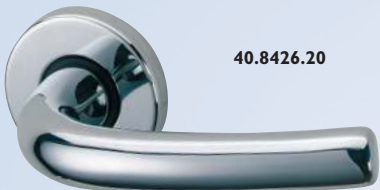

40.8426.20



40.8439.41

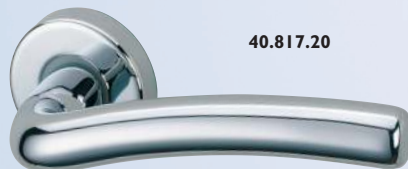

40.817.20



40.817.21

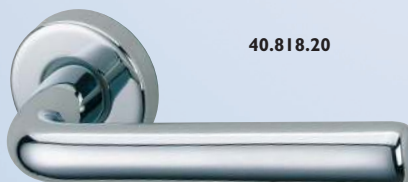

40.818.20



40.818.21

LEVER HANDLES



40.8470.21



40.8445.21



40.8466.21



40.8445.31



40.8445.43



40.8416.41

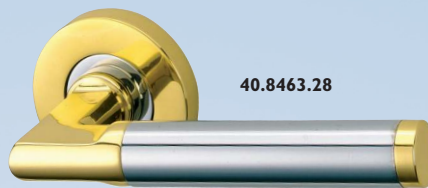

40.8463.28



40.8444.24



40.8463.24



40.8444.28

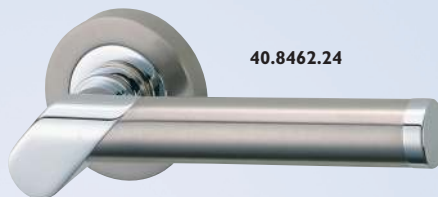

40.8462.24



40.8467.21



40.8462.31



40.8467.10

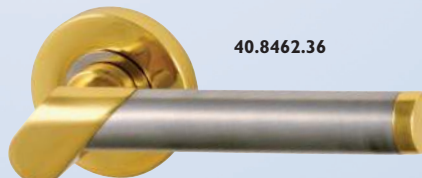

40.8462.36



40.8467.20

For matching Turn & Release
see page 80

ROUND ROSE LEVER HANDLES

40.8416.41	Rose 55mm	MNK
------------	-----------	-----

40.8444.24	Rose 55mm	CP/SS
------------	-----------	-------

40.8444.28	Rose 52mm	PB/CP
------------	-----------	-------

40.8445.21	Rose 52mm	SCP
------------	-----------	-----

40.8445.31	Rose 52mm	PB/SB
------------	-----------	-------

40.8445.43	Rose 52mm	MN/CP
------------	-----------	-------

40.8462.24	Rose 52mm	CP/SS
------------	-----------	-------

40.8462.31	Rose 52mm	PB/SB
------------	-----------	-------

40.8462.36	Rose 52mm	PB/SS
------------	-----------	-------

40.8463.24	Rose 52mm	CP/SS
------------	-----------	-------

40.8463.28	Rose 52mm	PB/CP
------------	-----------	-------

40.8466.21	Rose 55mm	SCP
------------	-----------	-----

40.8467.10	Rose 55mm	PB
------------	-----------	----

40.8467.20	Rose 55mm	CP
------------	-----------	----

40.8467.21	Rose 55mm	SCP
------------	-----------	-----

40.8470.21	Rose 52mm	SCP
------------	-----------	-----

LEVER HANDLES

All Lever Handles are supplied in pairs.

Spindle and fixing screws included.

For Mortise Latches, Locks and Bathroom Locks see pages 92-96

ROUND ROSE HANDLES

40.100 .10	Rose 57mm	PB
------------	-----------	----

LEVER LATCH WITHOUT KEYHOLE

41.100 .10	102x41mm	PB
------------	----------	----

41.100 .20	102x41mm	CP
------------	----------	----

41.100 .21	102x41mm	SCP
------------	----------	-----

41.105 .10	152x41mm	PB
------------	----------	----

41.105 .20	152x41mm	CP
------------	----------	----

41.105 .21	152x41mm	SCP
------------	----------	-----

41.105 .82	152x43mm	BJP
------------	----------	-----

41.180 .82	152x38mm	BJP
------------	----------	-----

LEVER LOCK WITH KEYHOLE

42.100 .10	152x41mm	PB
------------	----------	----

42.100 .20	152x41mm	CP
------------	----------	----

42.100 .21	152x41mm	SCP
------------	----------	-----

42.100 .82	152x43mm	BJP
------------	----------	-----

42.180 .82	152x38mm	BJP
------------	----------	-----

LEVER BATH PRIVACY WITH TURN & RELEASE

43.100 .10	152x41mm	PB
------------	----------	----

43.100 .20	152x41mm	CP
------------	----------	----

43.100 .21	152x41mm	SCP
------------	----------	-----

43.180 .82	152x38mm	BJP
------------	----------	-----



42.100.10



41.105.10



40.100.10



43.100.10



41.100.10



42.100.20



42.100.82
41.105.82
(Without Keyhole)



42.180.82



41.180.82



43.180.82

LEVER HANDLES

All Bathroom Lever Handles have Turn inside and Release outside.

ROUND ROSE HANDLES

40.230 .10	Rose 57mm	PB
40.230 .21	Rose 57mm	SCP

LEVER LATCH WITHOUT KEYHOLE

41.230 .10	120x40mm	PB
41.230 .21	120x40mm	SCP
41.285 .10	171x47mm	PB
41.285 .20	171x47mm	CP

LEVER LOCK WITH KEYHOLE

42.230 .10	152x43mm	PB
42.230 .21	152x43mm	SCP
42.280 .10	171x47mm	PB
42.280 .20	171x47mm	CP

LEVER BATH PRIVACY WITH TURN & RELEASE

43.230 .10	152x43mm	PB
43.230 .21	152x43mm	SCP
43.280 .10	171x47mm	PB
43.280 .20	171x47mm	CP



LEVER HANDLES

All Lever Handles are supplied in pairs.
Spindle and fixing screws included.
For Mortise Latches, Locks and Bathroom Locks see pages 92-96

ROUND ROSE HANDLES

40.200 .10	Rose 57mm	PB
40.200 .20	Rose 57mm	CP

LEVER LATCH WITHOUT KEYHOLE

41.200 .10	102x41mm	PB
41.200 .20	102x41mm	CP
41.205 .10	152x41mm	PB
41.205 .20	152x41mm	CP
41.990 .55	104x40mm, Alum	SAA

LEVER LOCK WITH KEYHOLE

42.200 .10	152x41mm	PB
42.200 .20	152x41mm	CP
42.201 .10	152x41mm, Euro Cylinder 48mm C-T-C	PB
42.201 .20	(as above)	CP
42.202 .10	152x41mm, Oval Cylinder 57mm C-T-C	PB
42.202 .20	(as above)	CP
42.990 .55	155x40mm, Alum	SAA

LEVER BATH PRIVACY WITH TURN & RELEASE

43.200 .10	152x41mm	PB
43.200 .20	152x41mm	CP
43.990 .55	155x40mm, Alum	SAA

C-T-C: Centre to Centre



42.990.55



41.990.55



43.990.55



42.200.10



41.200.10



43.200.10



40.200.10



41.205.10



40.200.20



42.200.20



42.201.10

LEVER HANDLES

All Bathroom Lever Handles have Turn inside and Release outside.



LEVER LATCH WITHOUT KEYHOLE		
41.210 .10	203x51mm	PB
41.220 .10	170x41mm	PB
41.220 .20	170x41mm	CP
41.220 .21	170x41mm	SCP

LEVER LOCK WITH KEYHOLE		
42.210 .10	203x51mm	PB
42.220 .10	170x41mm	PB
42.220 .20	170x41mm	CP
42.220 .21	170x41mm	SCP
42.221 .10	170x41mm, Euro Cylinder 48mm C-T-C	PB
42.222 .10	170x41mm, Oval Cylinder 57mm C-T-C	PB

LEVER BATH PRIVACY WITH TURN & RELEASE		
43.210 .10	203x51mm	PB
43.220 .10	170x41mm	PB
43.220 .20	170x41mm	CP
43.220 .21	170x41mm	SCP

LEVER HANDLES

All Lever Handles are supplied in pairs.
 Spindle and fixing screws included.
 For Mortise Latches, Locks and Bathroom Locks see pages 92-96

ROUND ROSE HANDLES

40.300 .10	Rose 57mm	PB
------------	-----------	----

LEVER LATCH WITHOUT KEYHOLE

41.300 .10	114x51mm	PB
------------	----------	----

41.305 .10	152x51mm	PB
------------	----------	----

41.320 .10	167x47mm	PB
------------	----------	----

LEVER LOCK WITH KEYHOLE

42.300 .10	152x51mm	PB
------------	----------	----

42.320 .10	167x47mm	PB
------------	----------	----

LEVER BATH PRIVACY WITH TURN & RELEASE

43.300 .10	152x51mm	PB
------------	----------	----

43.320 .10	167x47mm	PB
------------	----------	----



41.305.10



41.300.10



40.300.10



42.300.10



43.300.10



42.320.10



41.320.10



43.320.10

LEVER HANDLES

All Bathroom Lever Handles have Turn inside and Release outside.



41.350.10



43.350.10



42.350.10



41.355.10



43.360.10



42.360.10



41.360.10



43.380.10



42.380.10



41.380.10

LEVER LATCH WITHOUT KEYHOLE

41.350 .10	114x51mm	PB
41.355 .10	152x51mm	PB
41.360 .10	167x47mm	PB
41.380 .10	109x45mm	PB

LEVER LOCK WITH KEYHOLE

42.350 .10	152x51mm	PB
42.360 .10	167x47mm	PB
42.380 .10	152x45mm	PB

LEVER BATH PRIVACY WITH TURN & RELEASE

43.350 .10	152x51mm	PB
43.360 .10	167x47mm	PB
43.380 .10	152x45mm	PB

LEVER HANDLES

All Lever Handles are supplied in pairs. Spindle and fixing screws included.

For Mortise Latches, Locks and Bathroom Locks see pages 92-96

ROUND ROSE LEVER HANDLES

40.260 .10	Rose 55mm	PB
40.260 .20	Rose 55mm	CP
40.260 .21	Rose 55mm	SCP
40.490 .10	Rose 57mm	PB

LEVER LATCH WITHOUT KEYHOLE

41.260 .10	100x40mm	PB
41.260 .20	100x40mm	CP
41.260 .21	100x40mm	SCP

41.265 .10	150x40mm	PB
41.265 .20	150x40mm	CP
41.265 .21	150x40mm	SCP

41.490 .10	117x41mm	PB
41.495 .10	171x43mm	PB
* 41.496 .10	298x57mm	PB

LEVER LOCK WITH KEYHOLE

42.260 .10	150x40mm	PB
42.260 .20	150x40mm	CP
42.260 .21	150x40mm	SCP
42.490 .10	171x43mm	PB
42.495 .10	298x57mm	PB

LEVER BATH PRIVACY WITH TURN & RELEASE

43.260 .10	150x40mm	PB
43.260 .20	150x40mm	CP
43.260 .21	150x40mm	SCP

43.490 .10	171x43mm	PB
* 43.495 .10	298x57mm	PB

* Not Illustrated



LEVER HANDLES

ARTDECO RANGE

LEVER LATCH WITHOUT KEYHOLE

41.425 .10	63x43mm	PB
41.425 .20	63x43mm	CP
* 41.425 .21	63x43mm	SCP

41.427 .10	155x50mm	PB
41.427 .20	155x50mm	CP
41.427 .21	155x50mm	SCP

41.428 .10	205x50mm	PB
41.428 .20	205x50mm	CB
41.428 .21	205x50mm	SCP

LEVER LOCK WITH KEYHOLE

42.425 .10	155x50mm	PB
42.425 .20	155x50mm	CP
42.425 .21	155x50mm	SCP

42.428 .10	205x50mm	PB
42.428 .20	205x50mm	CP
42.428 .21	205x50mm	SCP

LEVER BATH PRIVACY WITH TURN & RELEASE

43.425 .10	155x50mm	PB
43.425 .20	155x50mm	CP
43.425 .21	155x50mm	SCP

* 43.428 .10	205x50mm	PB
* 43.428 .20	205x50mm	CP
43.428 .21	205x50mm	SCP

* Not Illustrated



42.428.20



42.425.10



42.425.21



42.428.10



41.425.10



41.425.20



42.425.20



43.425.10



41.427.20



41.427.10

LEVER HANDLES

All Lever Handles are supplied in pairs.
Spindle and fixing screws included.
For Mortise Latches, Locks and Bathroom Locks see pages 92-96

LEVER LATCH WITHOUT KEYHOLE

41.510 .10	171x47mm	PB
41.520 .10	248x47mm	PB
41.540 .10	102x51mm	PB
41.545 .10	152x51mm	PB

LEVER LOCK WITH KEYHOLE

42.510 .10	171x47mm	PB
42.520 .10	248x47mm	PB
42.540 .10	152x51mm	PB

LEVER BATH PRIVACY WITH TURN & RELEASE

43.510 .10	171x47mm	PB
43.520 .10	248x47mm	PB
43.540 .10	152x51mm	PB



LEVER HANDLES

PRINCESS SUITE



41.905.10



42.900.10



41.900.10



42.904.10



43.900.10



41.920.10



42.924.10



40.900.10



43.920.10

ROUND ROSE LEVER HANDLES

40.900 .10	Rose 57mm	PB
------------	-----------	----

LEVER LATCH WITHOUT KEYHOLE

41.900 .10	115x48mm	PB
41.905 .10	175x48mm	PB
41.920 .10	298x57mm	PB

LEVER LOCK WITH KEYHOLE

42.900 .10	175x48mm	PB
* 42.901 .10	175x48mm, Euro Cylinder 48mm C-T-C	PB
* 42.902 .10	175x48mm, Oval Cylinder 57mm C-T-C	PB
42.904 .10	175x48mm with Escutcheon Cover	PB
42.924 .10	298x57mm with Escutcheon Cover	PB

LEVER BATH PRIVACY WITH TURN & RELEASE

43.900 .10	175x48mm	PB
43.920 .10	298x57mm	PB

* Not Illustrated

C-T-C: Centre to Centre

JADO LEVER HANDLES

A small selection from the extensive range of high quality Door Hardware, made by **JADO** of Germany.

Lever Handles and Roses are sold separately to allow for a multitude of combinations.

Please ask for further details.

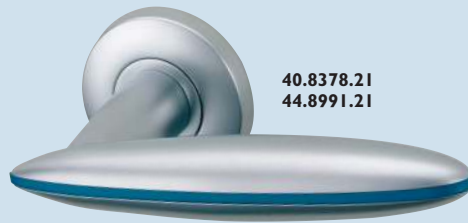

40.8378.21
44.8991.21



40.8380.21
44.8961.21



40.8380.22
44.8981.22



40.8395.22
44.8981.22

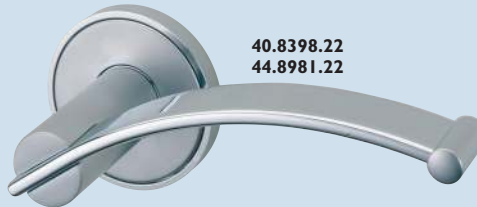

40.8398.22
44.8981.22



40.8402.20
44.8963.20



40.8395.25
44.8961.21



40.8408.22
44.8981.22



40.8409.22
44.8981.22



40.8900.10
44.8993.10



40.8408.28
44.8981.28



40.8409.28
44.8981.28



40.8949.10
44.8993.10



40.8930.22
44.8981.22



40.8411.28
44.8981.28

JADO LEVER HANDLES

A small selection from the extensive range of high quality Door Hardware, made by **JADO** of Germany.

Lever Handles and Back Plates are sold separately to allow for a multitude of combinations.

Please ask for further details.



40.8395.22
44.8342.22



40.8409.28
44.8342.28

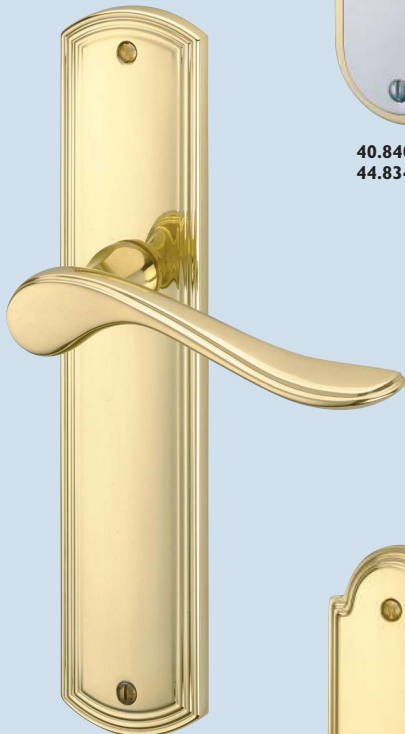

40.8908.10
44.8959.10



40.8901.10
44.8958.10



40.8933.10
44.8983.10



40.8949.10
44.8990.10



40.8918.10
44.8967.10

ESCUTCHEONS

For Cabinet Escutcheons
see page 28

44.133.10	45mm	PB
44.140.10	44mm, Forged	PB
44.140.20	44mm, Forged	CP
44.150.10	55mm, Forged	PB
	Also in CP & SCP	
44.180.10	65mm, Cast	PB
44.240.10	32mm (2mm thick)	PB
	Also in CP,SCP,SNP & IBMA	
44.280.10	42mm, Forged	PB
44.295.03	65mm, Iron	PATIN
44.300.60	Ceramic, 60mm	WHITE
44.300.62	Ceramic, 60mm	BLACK
44.300.69	Ceramic, 60mm	WH/GO
44.310.15	Cut Crystal, Glass 60mm	PB/CL
44.365.10	32mm	PB
	Also in CP,SCP,SNP & IBMA	
44.370.10	32mm, Pressed	PB
	Also in CP & SCP	
44.375.10	32mm, Forged	PB
	Also in CP & SCP	
44.400.13	58x44mm	PB/UL
44.400.50	S/Steel, 58x44mm	PSS
44.400.51	S/Steel, 58x44mm	SSS
44.414.10	44x28mm	PB
	Also in CP & SCP	
44.425.10	40x20mm, Forged	PB
44.425.20	40x20mm, Forged	CP
44.444.10	32mm, Forged	PB
	Also in SAB, CP,SCP & SNP	
44.448.10	32mm, Pressed	PB
44.448.20	32mm, Pressed	CP
44.470.10	48mm, Forged	PB
44.480.10	65mm, Cast	PB
44.488.10	56mm, Forged	PB
44.490.10	32mm, Forged	PB
44.500.10	32mm, Forged	PB
44.510.10	40mm, Forged	PB
44.540.10	32mm, Pressed	PB
44.545.10	32mm, Cast	PB
44.550.10	32mm, Forged	PB
44.610.10	32mm, Pressed	PB
44.680.82	45x30mm, Cast Iron	BJP
44.684.10	50mm, Pressed	PB
44.686.82	48mm, Cast Iron	BJP
44.690.10	50mm, Oval Pressed	PB
44.708.10	45mm (3.2mm thick)	PB
	Also in CP & SCP	
44.900.10	32mm, Princess	PB
44.906.10	44mm, Princess Oval	PB
44.910.10	Oval Cyl, 52mm	PB
44.912.10	Euro Cyl, 52mm	PB



ESCUTCHEONS



44.718.20



44.719.20



44.718.21



44.719.21



44.710.10



44.710.20



44.710.28



44.710.21



44.715.10



44.715.20



44.715.21



44.732.41



44.730.10



44.730.20



44.730.41



44.7332.51



44.780.55



44.782.55



44.783.55



44.7582.82



44.7522.10



44.7522.20



44.7522.21



44.7523.20



44.7532.10



44.7532.20



44.7532.21



44.7533.10



44.790.10



44.790.20



44.790.21



44.790.53



44.793.10



44.793.20



44.793.21



44.792.53

44.710.10	50mm	PB
44.710.20	50mm	CP
44.710.21	50mm	SCP
44.710.28	50mm	CP/PB
44.715.10	Euro Cyl, 50mm	PB
44.715.20	Euro Cyl, 50mm	CP
44.715.21	Euro Cyl, 50mm	SCP
* 44.715.28	Euro Cyl, 50mm	PB/CP
44.718.20	45mm	CP
44.718.21	45mm	SCP
44.719.20	Euro Cyl, 45mm	CP
44.719.21	Euro Cyl, 45mm	SCP
44.730.10	50mm	PB
44.730.20	50mm	CP
44.730.41	50mm	MNK
* 44.732.10	Euro Cyl, 50mm	PB
* 44.732.20	Euro Cyl, 50mm	CP
44.732.41	Euro Cyl, 50mm	MNK
44.7332.51	50mm, S/Steel	SSS
44.7522.10	Euro Cyl, 50x2mm	PB
44.7522.20	Euro Cyl, 50x2mm	CP
44.7522.21	Euro Cyl, 50x2mm	SCP
* 44.7523.10	Oval Cyl, 50x2mm	PB
44.7523.20	Oval Cyl, 50x2mm	CP
* 44.7523.21	Oval Cyl, 50x2mm	SCP
44.7532.10	Euro Cyl, 50x3.2mm	PB
44.7532.20	Euro Cyl, 50x3.2mm	CP
44.7532.21	Euro Cyl, 50x3.2mm	SCP
44.7533.10	Oval Cyl, 50x3.2mm	PB
* 44.7533.20	Oval Cyl, 50x3.2mm	CP
* 44.7533.21	Oval Cyl, 50x3.2mm	SCP
44.7582.82	Euro Cyl, Iron, 50mm	BJP
44.780.55	50mm	SAA
44.782.55	Euro Cyl, 50mm	SAA
44.783.55	Oval Cyl, 50mm	SAA
44.790.10	50mm	PB
44.790.20	50mm	CP
44.790.21	50mm	SCP
44.790.53	50mm	IBMA
* 44.792.10	Euro Cyl, 50mm	PB
* 44.792.20	Euro Cyl, 50mm	CP
* 44.792.21	Euro Cyl, 50mm	SCP
44.792.53	Euro Cyl, 50mm	IBMA
44.793.10	Oval Cyl, 50mm	PB
44.793.20	Oval Cyl, 50mm	CP
44.793.21	Oval Cyl, 50mm	SCP

Not Illustrated *

THUMBTURNS & RELEASES

★	45.045.10	Turn Only, 40x20mm	PB
★	45.045.20	Turn Only, 40x20mm	CP
★	45.046.10	Release, 40x20mm	PB
★	45.046.20	Release, 40x20mm	CP
	45.047.10	Turn Only, 38mm	PB
	45.048.10	Release Escut, 30mm	PB
	45.051.10	Turn Only, 32mm	PB
	45.051.20	Turn Only, 32mm	CP
	45.051.21	Turn Only, 32mm	SCP
	45.052.10	Release Only, 32mm	PB
	45.052.20	Release Only, 32mm	CP
	45.052.21	Release Only, 32mm	SCP
★	45.062.10	Turn Only, 35mm	PB
★	45.062.20	Turn Only, 35mm	CP
★	45.062.21	Turn Only, 35mm	SCP
★	45.062.40	Turn Only, 35mm	NP
★	45.062.41	Turn Only, 35mm	SNP
★	45.062.53	Turn Only, 35mm	IBMA
★	45.064.10	Release Only, 35mm	PB
★	45.064.20	Release Only, 35mm	CP
★	45.064.21	Release Only, 35mm	SCP
★	45.064.40	Release Only, 35mm	NP
★	45.064.41	Release Only, 35mm	SNP
★	45.064.53	Release Only, 35mm	IBMA
	45.068.82	Turn & Rel, Iron, 38mm	BJP
	45.070.10	Turn & Release, 35mm	PB
	45.070.20	Turn & Release, 35mm	CP
	45.070.21	Turn & Release, 35mm	SCP
	45.073.10	Turn & Release, 50mm	PB
	45.073.20	Turn & Release, 50mm	CP
	45.073.41	Turn & Release, 50mm	MNK
	45.078.10	Turn & Release, 43mm	PB
	45.078.20	Turn & Release, 43mm	CP
	45.088.10	Turn & Release, 45mm	PB
	45.088.20	Turn & Release, 45mm	CP
	45.088.21	Turn & Release, 45mm	SCP
	45.091.10	Turn Only, 38mm	PB
	45.092.10	Release Escut, 30mm	PB

★ 1/4" Pinion or 5mm Spindle



THUMBTURNS & RELEASES



45.075.10

45.083.10



45.075.18

45.083.20



45.075.20

45.083.21



45.075.21

45.083.28



45.075.24

45.083.53



45.075.28

45.081.20



45.075.31

45.081.21



45.028.55

45.0331.51



45.0332.51

45.0335.52

45.028.55	Turn & Release, 51mm	SAA
45.0331.51	Turn & Release, 52mm	SSS
45.0332.51	Turn & Release, 52mm	SSS
45.0332.52	Turn & Release, 52mm	SS/PS
45.0335.52	Turn & Release, 52mm	SS/PS
45.075.10	Turn & Release, 50mm	PB
45.075.18	Turn & Release, 50mm	PB/MN
45.075.20	Turn & Release, 50mm	CP
45.075.21	Turn & Release, 50mm	SCP
45.075.24	Turn & Release, 50mm	CP/MN
45.075.28	Turn & Release, 50mm	PB/CP
45.075.31	Turn & Release, 50mm	PB/SB
45.075.41	Turn & Release, 50mm	MNK
45.075.43	Turn & Release, 50mm	MN/CP
45.081.10	Turn & Release, 50mm	PB
45.081.20	Turn & Release, 50mm	CP
45.081.21	Turn & Release, 50mm	SCP
45.083.10	Turn & Release, 50mm	PB
45.083.20	Turn & Release, 50mm	CP
45.083.21	Turn & Release, 50mm	SCP
45.083.28	Turn & Release, 50mm	PB/CP
45.083.53	Turn & Release, 50mm	IBMA

FOR FURTHER INFORMATION
ON FINISH DETAILS SEE PAGE I

KNOB FURNITURE

45.316.15	Crystal Cut-Glass Ball	
	Knob 50mm, 60mm	
	Rose 56mm, 65mm	PB/CL
45.316.21	(as above)	SC/CL
45.316.25	(as above)	CP/CL

45.360.15	Clear Glass Ball	
	Knob 60mm	
	Rose 55mm	PB/CL
45.360.21	(as above)	SC/CL
45.360.25	(as above)	CP/CL

45.365.15	Clear Glass Fluted	
	Knob 58mm	
	Rose 55mm	PB/CL
45.365.21	(as above)	SC/CL
45.365.25	(as above)	CP/CL

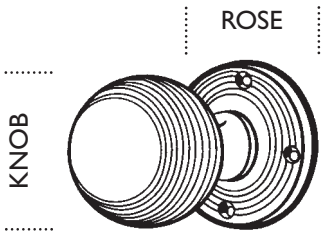

45.360.21



45.360.15



45.360.25



45.365.21



45.365.15



45.365.25



45.316.15
(50mm)



45.316.21
(60mm)



45.316.25
(60mm)

KNOB FURNITURE

45.300 .60	Ceramic, (Metal Collar) Knob 57mm Rose 62mm	WHITE
45.300 .62	(as above)	BLACK
45.300 .69	(as above)	WH/GO
45.305 .16	Ceramic Knob, 57mm Brass Rose 62mm	PB/WH
45.310 .60	Ceramic, Knob 58mm Rose 58mm	WHITE
45.310 .62	(as above)	BLACK
45.310 .69	(as above)	WH/GO
45.320 .15	Crystal, Knob 51mm Rose 62mm	PB/CL
45.330 .15	Acrylic, Knob 58mm Rose 58mm	PB/CL
45.330 .25	(as above)	CP/CL
45.340 .15	Acrylic, Knob 56mm Rose 58mm	PB/CL
45.340 .25	(as above)	CP/CL
45.350 .15	Acrylic, Knob 50mm Rose 58mm	PB/CL
45.350 .25	(as above)	CP/CL
45.685 .82	Iron, Knob 43mm, Rose 64mm	BJP
45.695 .82	Iron, Knob 64x40mm, Rose 64mm	BJP
49.9952.00	Dummy Plate	S/COL
49.9960.00	Dummy Spindle	S/COL
49.9966.00	Spindle Collar	S/COL
49.9968.00	Dummy Spindle	S/COL

**FOR FURTHER INFORMATION
ON FINISH DETAILS SEE PAGE I**



45.300.60



45.310.60



45.310.69



45.300.69



45.305.16



45.320.15



45.300.62



45.695.82



45.685.82



45.340.15



45.330.15



45.350.25



49.9968.00



49.9960.00



49.9966.00



49.9952.00

KNOB FURNITURE

45.140 .10	Ring Furniture, 65mm, 75mm	PB
45.160 .10	Ring Furniture, 65mm, 75mm	PB
45.175 .10	Flush Ring, 65x65mm 75x75mm	PB
45.175 .20	Flush Ring, 65x65mm 75x75mm	CP
45.175 .21	Flush Ring, 65x65mm 75x75mm	SCP
	(also SNP & IBMA)	
45.178 .10	Round Flush Ring 65mm, 75mm	PB
45.178 .20	Round Flush Ring 65mm, 75mm	CP
45.178 .21	Round Flush Ring 65mm, 75mm	SCP
45.180 .10	Squash Court Handle 90x90mm	PB
45.180 .21	Squash Court Handle 90x90mm	SCP
45.370 .10	Knob 50mm, 55mm, Rose 51mm, 57mm (Threaded Spindle)	PB
45.390 .10	Knob 47mm, Rose 57mm	PB
45.390 .20	(as above)	CP
45.390 .21	(as above)	SCP
45.390 .53	(as above)	IBMA
45.390 .54	(as above)	RBMA
45.410 .10	Knob 51mm, 57mm, Rose 58mm, 64mm	PB
45.410 .20	(as above)	CP
45.410 .21	(as above)	SCP
45.411 .10	as 45.410 .10 but to suit Rim Locks (See page 97)	PB
	(also CP & SCP)	

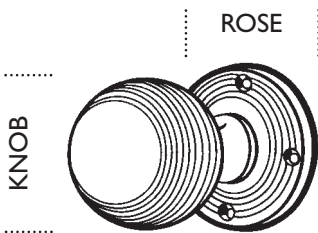

KNOB FURNITURE



45.448.20



45.448.10



45.448.41



45.425.20



45.425.10



45.404.21
(57mm)



45.404.20
(63mm)



45.404.10
(63mm)



45.404.21
(50mm)



45.404.53
(50mm)



45.404.10
(57mm)



45.404.10
(50mm)



45.404.41
(50mm)



45.404.20
(50mm)



45.444.20



45.444.21



45.444.10



45.445.10

Knob furniture should be used with Locks or Latches which have a deep backset to avoid crushing your knuckles against the door stop/frame.

45.404 .10	Knob 50mm, 57mm, 63mm Rose 57mm, 63mm, 70mm	PB
45.404 .20	(as above)	CP
45.404 .21	(as above)	SCP
45.404 .41	(as above)	SNP
45.404 .53	(as above)	IBMA
45.405 .10	Knob 50mm, 57mm, Rose 57mm, 63mm	
To suit Rim Locks		
(See page 97)		PB
45.405 .20	(as above)	CP
45.405 .21	(as above)	SCP
45.425 .10	Knob 60x35mm Rose 63x43mm	PB
45.425 .20	(as above)	CP
45.425 .21	(as above)	SCP
45.444 .10	Knob 52mm, Rose 60mm	PB
45.444 .20	(as above)	CP
45.444 .21	(as above)	SCP
45.445 .10	Knob 52mm, Rose 60mm	
To suit Rim Locks		
(See page 97)		PB
(Also CP & SCP)		
45.448 .10	Knob 62mm, Heavy Cast Rose 64mm	PB
45.448 .20	(as above)	CP
45.448 .41	(as above)	SNP

KNOB FURNITURE

45.450 .10	Knob 59mm, Rose 70mm	PB
45.465 .10	Knob 52mm, Cast Brass, Rose 60mm	PB
45.468 .10	Forged Brass Knob 50mm, 60mm, Rose 60mm, 75mm	PB
45.490 .10	Knob 51mm, 65mm, Rose 57mm, 76mm	PB
45.500 .10	Knob 52mm, Rose 57mm	PB
45.510 .10	Knob 51mm, Rose 57mm	PB
45.5239.10	Knob 57mm, Rose 70mm	PB
45.5239.20	Knob 57mm, Rose 70mm	CP
45.5239.21	Knob 57mm, Rose 70mm	SCP
45.540 .10	Knob 51mm, Rose 57mm	PB
45.540 .20	(as above)	CP
45.550 .10	Knob 52mm, Rose 59mm	PB
45.575 .10	Knob 58mm, Rose 65mm	PB
45.612 .10	Knob 60x41mm, Rose 57x57mm	PB
45.612 .20	(as above)	CP

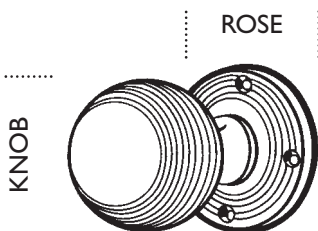

45.450.10



45.490.10
(65mm)



45.540.10



45.575.10



45.490.10
(51mm)



45.540.20



45.550.10



45.5239.21



45.468.10
(50mm)



45.468.10
(60mm)



45.5239.20



45.465.10



45.612.10



45.5239.10



45.500.10



45.612.20



45.510.10

KNOB FURNITURE

Knob furniture should be used with Locks or Latches which have a deep backset to avoid crushing your knuckles against the door stop/frame.



45.900.10
(64mm)



45.888.10
(69mm)



45.900.10
(51mm)



45.808.10



45.860.20



45.906.10

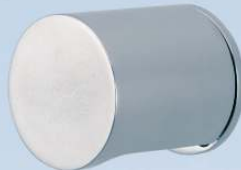

45.808.20



45.860.10



45.660.53



45.808.21



45.860.82



45.660.21



45.661.10



45.665.21



45.660.20



45.660.10



45.665.10

45.660 .10	Knob 58x40mm, Rose 57mm	PB
45.660 .20	as above	CP
45.660 .21	as above	SCP
45.660 .41	as above	SNP
45.660 .53	as above	IBMA
45.661 .10	Knob 58x40mm, Rose 57mm	
	To suit Rim Locks (see page 97)	PB
45.661 .20	(as above)	CP
45.661 .21	(as above)	SCP
45.665 .10	Knob 58x40mm, Cover Rose 60mm	PB
45.665 .20	(as above)	CP
45.665 .21	(as above)	SCP
45.808 .10	Knob 45mm, Rose 45mm	PB
45.808 .20	(as above)	CP
45.808 .21	(as above)	SCP
45.860 .10	Knob 57mm, Rose 70mm	PB
45.860 .20	(as above)	CP
45.860 .82	Knob 53mm, Rose 61mm, Iron	BJP
45.888 .10	Knob 63mm, 69mm, Rose 66mm, 82mm	PB
45.900 .10	Knob 51mm, 64mm, Rose 57mm, 76mm	PB
45.906 .10	Knob 64x38mm, Rose 57mm	PB

**FOR FURTHER INFORMATION
ON FINISH DETAILS SEE PAGE I**

FINGERPLATES

46.116 .10	280x57mm, 305x76mm	PB
46.116 .50	Stainless Steel 305x76mm	PSS
46.116 .51	Stainless Steel 305x76mm	SSS
46.116 .55	Aluminium 305x76mm	SAA
46.140 .10	305x63mm, 305x76mm	PB
46.250 .10	305x65mm	PB
46.250 .20	305x65mm	CP
46.280 .10	305x65mm	PB
46.320 .05	Crystal Glass 280x76mm (not illustrated)	CLEAR
46.330 .60	Ceramic 280x76mm	WHITE
46.330 .62	Ceramic 280x76mm	BLACK
46.330 .69	Ceramic 280x76mm	WH/GO
46.350 .05	Acrylic, 12"x3"	CLEAR
46.425 .10	305x63mm	PB
46.425 .20	305x63mm	CP
46.444 .10	305x70mm	PB
46.490 .10	298x57mm	PB
46.500 .10	300x57mm	PB
46.510 .10	300x55mm	PB
46.540 .10	305x70mm	PB
46.610 .10	305x74mm	PB
46.750 .10	300x60mm	PB
46.780 .10	458x76mm	PB
46.900 .10	298x57mm	PB



46.780.10



46.444.10



46.140.10



46.350.05



46.330.60



46.116.50



46.116.55



46.116.10



46.116.60



46.500.10



46.425.10



46.610.10



46.250.10



46.540.10



46.510.10



46.280.10



46.750.10



46.900.10



46.490.10

LOCKS

CABINET LOCKS



WINDOW LOCKS



MORTISE LATCHES



MORTISE LOCKS



RIM LOCKS



NIGHT LATCHES

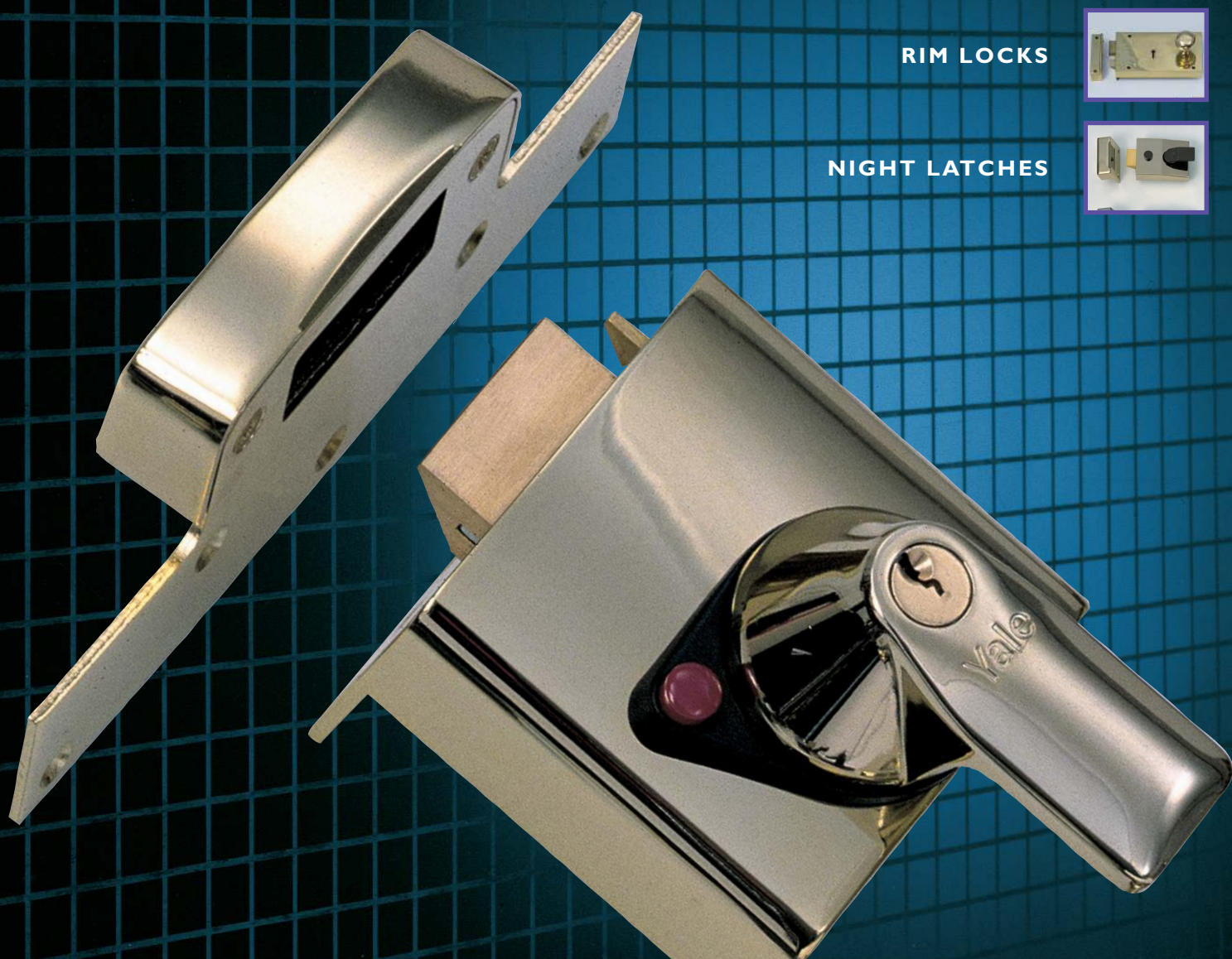

CABINET LOCKS

All cupboard locks are supplied with 2 keys.
For Escutcheons see page 28.

47.1011.08	1 Lever, 2", 2½", 3"	BB
47.1012.08	2 Lever, 2", 2½", 3"	BB
47.1014.08	4 Lever, 2", 2½", 3"	BB
47.1021.08	1 Lever, LH or RH 2", 2½", 3"	BB
47.1022.08	2 Lever, LH or RH 2", 2½", 3"	BB
47.1032.08	2 Lever, LH or RH 2½", 3"	BB
47.1034.08	4 Lever, LH or RH 2½"	BB
47.1041.08	1 Lever Drawer Lock 1½", 2"	BB
47.1042.08	2 Lever Drawer Lock 1½", 2", 2½"	BB
47.1044.08	4 Lever Drawer Lock 2", 2½", 3"	BB
47.1052.08	2 Lever Box Lock 1½", 2"	BB
47.1054.08	4 Lever Box Lock 3"	BB
47.1080.82	Straight, Iron, 4"	BJP
47.1099.10	Roll Top Desklock	PB
47.1125.10	Cylinder Lock 45mm	PB
47.1130.10	Cylinder Lock 50mm	PB
47.1185.08	Strike Plate	BB
47.1186.08	Strike Plate, Offset	BB
47.1187.08	Strike Plate, Angled	BB
47.1920.81	Budget Lock 89x19mm	BZP
47.1930.81	Rim Budget Lock (LH or RH) 79mm	BZP
47.1950.81	Budget Lock Key	BZP
47.2010.82	Hasp & Staple 75, 115, 150mm	BJP
47.2020.08	Brass Padlock, 20, 25, 30, 40, 50, 60mm	BB

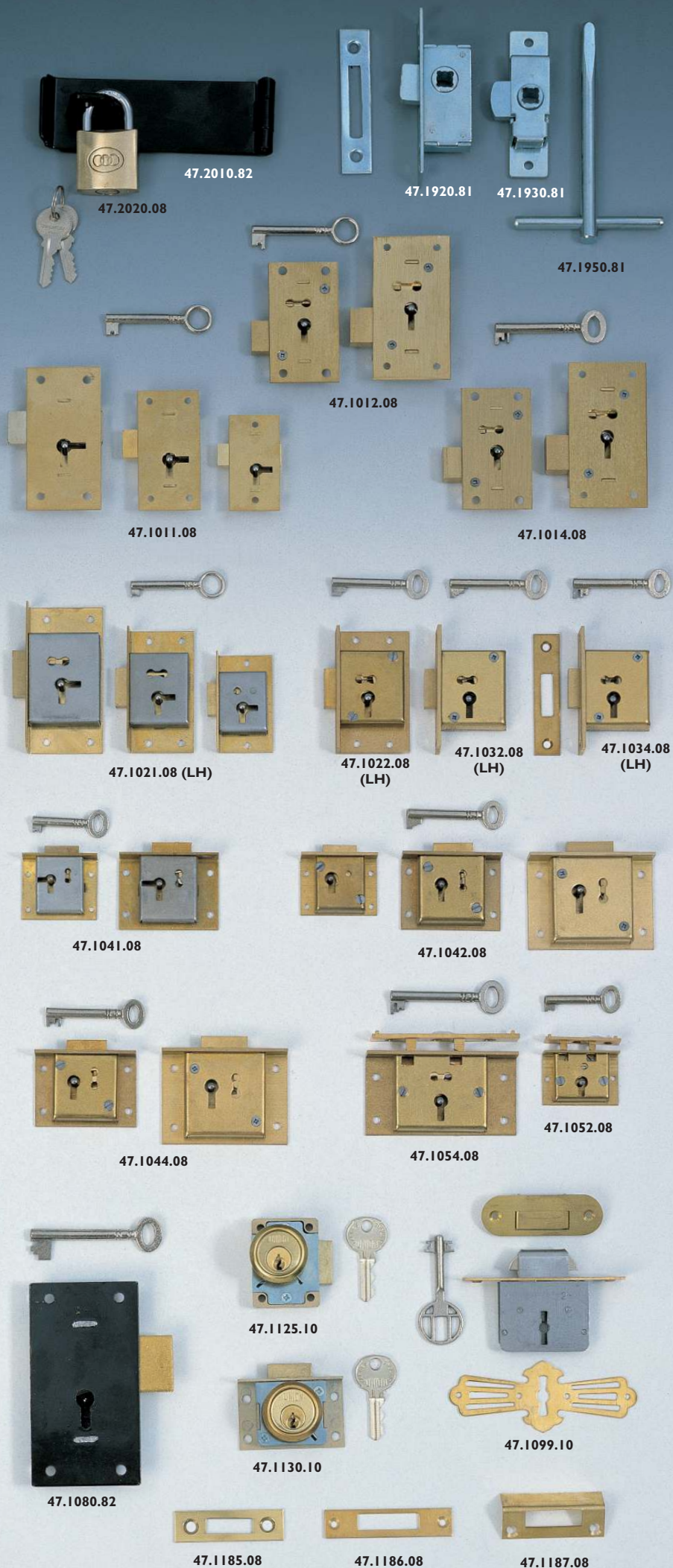

WINDOW LOCKS



47.6040.10	Sash Stop/2 Keeps	PB
47.6040.40	Sash Stop/2 Keeps	NP
47.6050.80	Staylock & Key	EBP
47.6050.81	Staylock & Key	BZP
47.6060.80	Hinge Bolt (Pair)	EBP
47.6060.81	Hinge Bolt (Pair)	BZP
47.6130.60	Unibolt/Std Key	WHITE
47.6140.81	2 Sash Stops, Plate+Key	BZP
47.6150.60	Pressbolt/Std Key	WHITE
47.6160.60	Pressbolt/Sp Key	WHITE
47.6160.80	Pressbolt/Sp Key	EBP
47.8010.10	Security Bolt, 32mm	PB
47.8010.60	Security Bolt, 32mm	WH
47.8020.10	Security Bolt, 60mm	PB
47.8020.60	Security Bolt, 60mm	WH
47.8029.00	Key for Security Bolt 85mm, 114mm	S/COL
47.8030.10	Sash Window Screw	PB
47.8039.00	Key for Dual Screw	
47.8040.10	Sash Window Stop	PB
47.8040.20	Sash Window Stop	CP
47.8040.21	Sash Window Stop	SCP
47.8049.00	Key for Sash Stop	
47.8060.10	Flip-Over Lock	PB
47.8060.60	Flip-Over Lock	WHITE
47.8060.63	Flip-Over Lock	BROWN
47.8069.00	Key for 47.8060 Lock	
47.8070.10	Push to Lock	PB
47.8070.60	Push to Lock	WHITE
47.8079.00	Key for 47.8070 Lock	
47.8090.60	Metal Window	WHITE
47.8120.60	Hinge Bolts (Pr)	WHITE
47.8130.10	Door Viewer, 160°	PB
47.8130.20	Door Viewer, 160°	CP
47.8140.10	Door Viewer, 180°	PB
47.8140.20	Door Viewer, 180°	CP
47.8145.10	Door Viewer, Super	PB
47.8145.20	Door Viewer, Super	CP
47.8440.10	Door Viewer, 200°	PB
47.8440.40	Door Viewer, 200°	NP
47.9020.60	Ingersoll Sash Stop	WHITE
47.9030.60	Metal Window	WHITE
47.9090.00	Key for Ingersoll Lock	

MORTISE LATCHES

All measurements are overall sizes. Rebate sets are required when used on rebated doors.

Backset measurement between spindle and door edge.

Overall (mm)	65	75	80	95	100	125	150
Backset (mm)	44	57	60	76	82	102	127

TUBULAR LATCH

48.1100.10	95mm Standard	PB
48.1100.40	95mm Standard	NP
48.1120.10	65, 75mm, Light	PB
48.1120.40	65, 75mm, Light	NP
48.1120.80	65, 75mm, Light	EBP
48.1140.10	80, 100, 125, 150mm, Strong	PB
48.1140.11	80, 100, 125, 150mm, Strong	SAB
48.1140.50	80, 100, 125, 150mm, Strong	PSS
48.1140.51	80, 100, 125, 150mm, Strong	SSS
48.1160.00	75, 100, 125mm, Bolt-Thru, with EBP & SCP Strike Plate	
48.1190.10	Rebate for 48.1100 + 48.1120	PB
48.1190.40	(as above)	NP
48.1192.11	Rebate for 48.1140	SAB
48.1192.51	(as above)	SSS

MORTISE LATCH HEAVY SPRUNG

48.1300.10	65mm, 75mm	PB
48.1300.21	65mm, 75mm	SCP
48.1388.10	Extended Strike Plate	PB
48.1388.21	(as above)	SCP

HORIZONTAL MORTISE LATCH

48.1500.10	125mm, 150mm	PB
48.1500.21	125mm, 150mm	SCP

OVAL & EURO PROFILE CYLINDERS

48.9930.10	Key+Turn, 65mm, 75mm	PB
48.9930.21	Key+Turn, 65mm, 75mm	SCP
48.9932.10	Key+Key, 65mm, 75mm	PB
48.9932.21	Key+Key, 65mm, 75mm	SCP
48.9935.10	Single Key, 40mm	PB
48.9935.21	Single Key, 40mm	SCP
48.9950.10	Key+Turn, 65mm, 75mm	PB
48.9950.21	Key+Turn, 65mm, 75mm	SCP
48.9952.10	Key+Key, 65mm, 75mm	PB
48.9952.21	Key+Key, 65mm, 75mm	SCP
48.9955.10	Single Key, 40mm	PB
48.9955.21	Single Key, 40mm	SCP

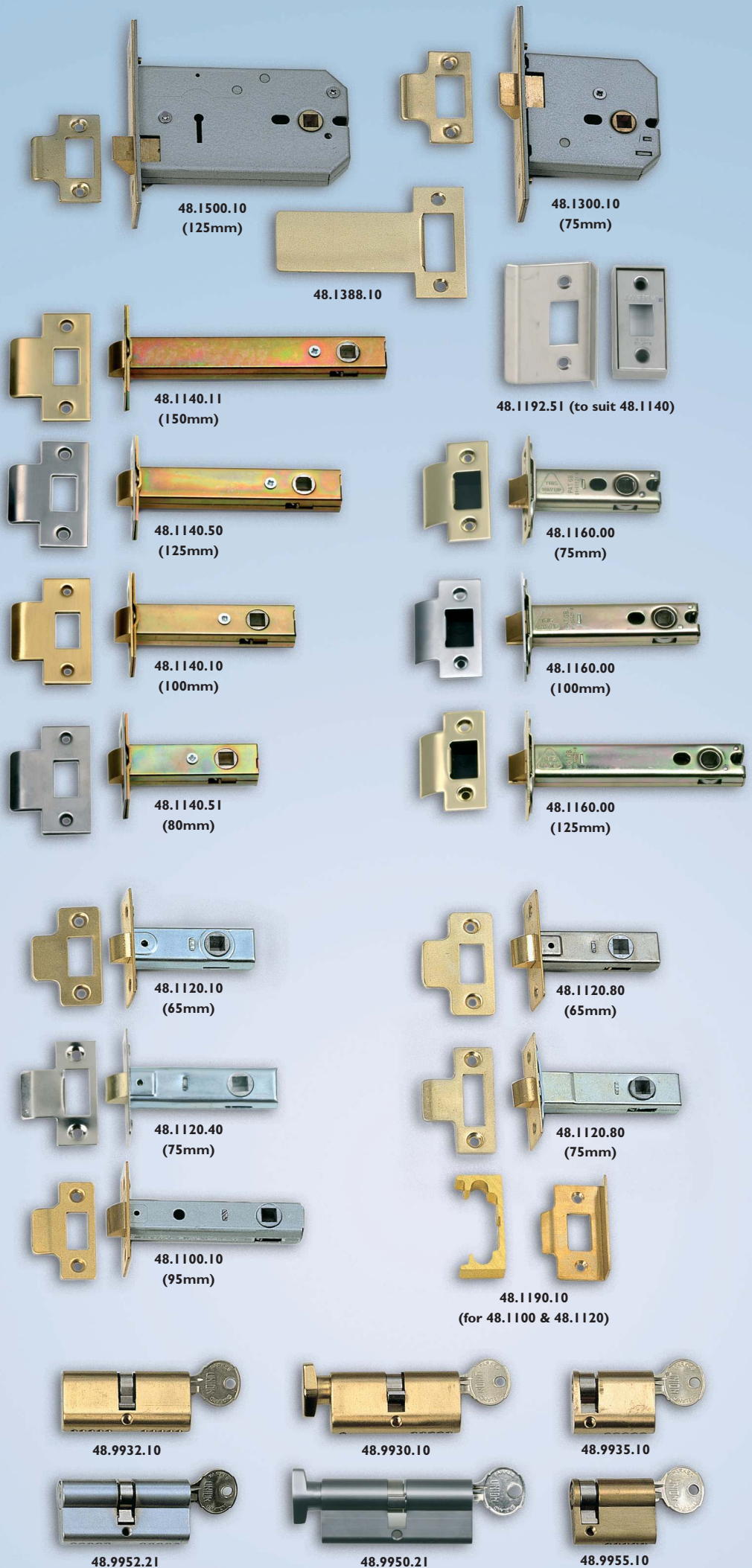

MORTISE LOCKS

All measurements are overall sizes. Rebate sets are required when used on rebated doors.

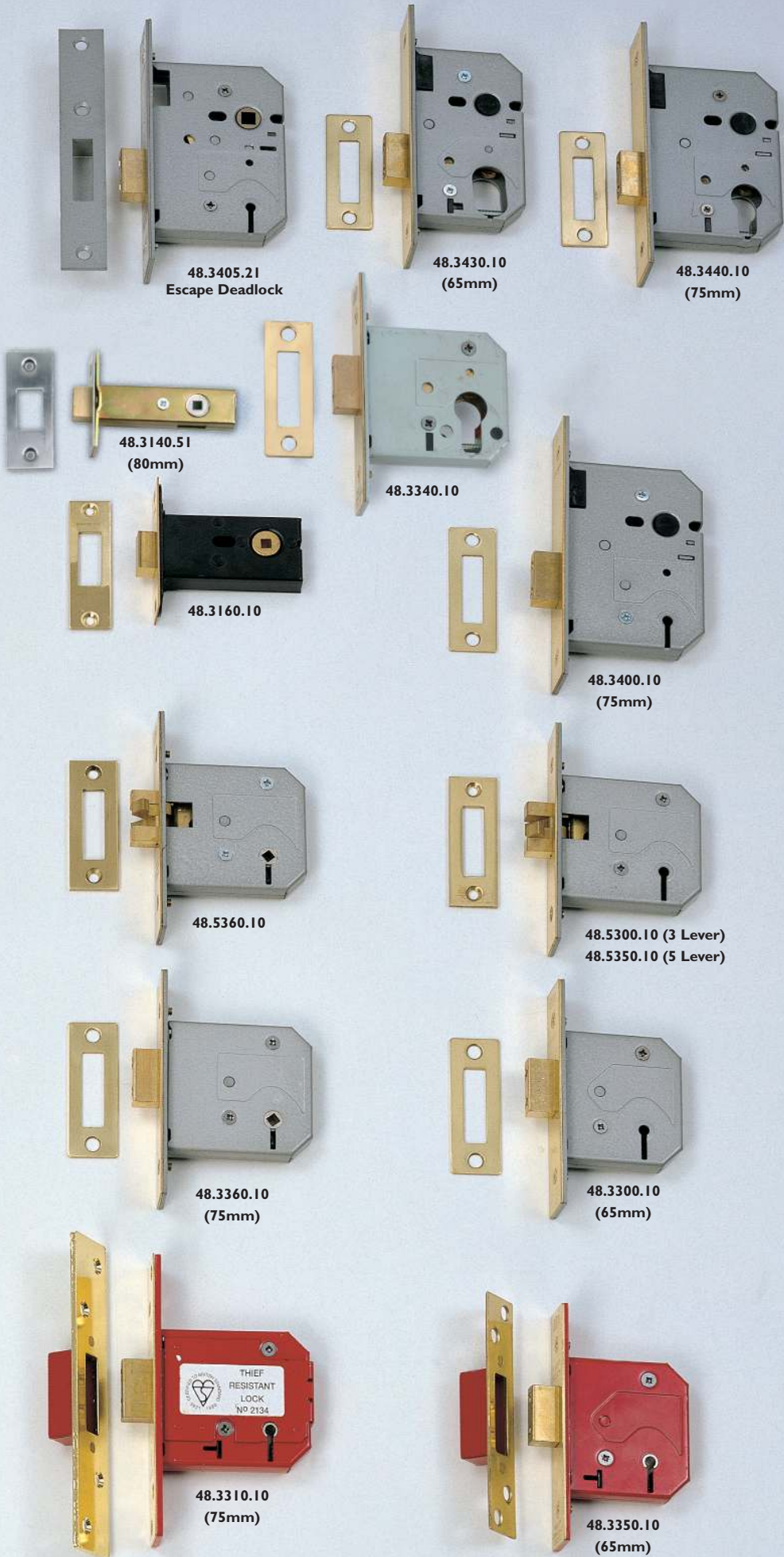

MORTISE DEADLOCK

48.3140.11	Turn Operated	80, 100, 125, 150mm	SAB	■
48.3140.51	(As above)		SSS	■
48.3160.10	Turn Operated 75mm		PB	■
48.3160.21	(as above)		SCP	■
48.3300.10	3 Lever 65mm, 75mm		PB	
48.3300.21	(as above)		SCP	
48.3310.10	5 Lever, Kitemark,	50mm, 65mm, 75mm	PB	
48.3310.21	(as above)		SCP	
48.3340.10	Euro, Case only, 75mm		PB	
48.3340.21	(as above)		SCP	
48.3350.10	5 Lever	65mm, 75mm	PB	
48.3350.21	(as above)		SCP	
48.3360.10	Turn Operated	65mm, 75mm	PB	
48.3360.21	(as above)		SCP	
48.3400.10	3L Upright Deadlock	65mm, 75mm	PB	
48.3400.21	(as above)		SCP	
48.3405.10	Escape Deadlock	3 Lever, 75mm	PB	
48.3405.21	(as above)		SCP	
48.3430.10	Oval Cylinder 65mm,	75mm, 100mm	PB	
48.3430.21	(as above)		SCP	
48.3440.10	Euro Cyl, Case only	75mm	PB	
48.3440.21	(as above)		SCP	
48.5300.10	3 Lever,	Clawbolt, 75mm	PB	
48.5300.21	(as above)		SCP	
48.5350.10	5 Lever,	Clawbolt, 75mm	PB	
48.5350.21	(as above)		SCP	
48.5360.10	Turn Operated	Clawbolt, 75mm	PB	■
48.5360.21	(as above)		SCP	■

■ 3/16" (5mm) Sq Spindle

PLEASE ASK FOR INFORMATION ON REBATE SETS AVAILABLE FOR THE ABOVE LOCKS

MORTISE LOCKS

All measurements are overall sizes. Rebate sets are required when used on rebated doors. All Locks (except Bath Locks) come with 2 keys. Backset measurement between spindle and door edge.

Overall (mm)	50	65	75	100	125	150
Backset (mm)	32	44	57	82	102	127

48.4200.10	2 Lever Sashlock	65mm, 75mm	PB
48.4200.20	2 Lever Sashlock	65mm, 75mm	CP
■ 48.4260.10	Bathroom Lock	65mm, 75mm	PB
■ 48.4260.20	Bathroom Lock	65mm, 75mm	CP
48.4290.80	2 Lever, Rebated	65mm, 75mm	EBP
48.4290.85	2 Lever, Rebated	65mm, 75mm	SE
48.4400.10	3 Lever 50mm, 65mm,	75mm, 100mm	PB
48.4400.21	3 Lever 50mm, 65mm,	75mm, 100mm	SCP
■ 48.4460.10	Bathroom Lock, 65mm,	75mm, 100mm	PB
■ 48.4460.21	Bathroom Lock, 65mm,	75mm, 100mm	SCP
48.4488.10	Extended Strike Plate		PB
48.4488.21	Extended Strike Plate		SCP

HORIZONTAL MORTISE LOCKS

48.4500.10	3 Lever,	125mm, 150mm	PB
48.4500.21	3 Lever,	125mm, 150mm	SCP
48.4530.10	Oval Cylinder, 150mm		PB
48.4530.21	Oval Cylinder, 150mm		SCP
48.4540.10	Euro Cyl, 150mm		PB
48.4540.21	Euro Cyl, 150mm		SCP
■ 48.4560.10	Bathroom Lock	125mm, 150mm	PB
■ 48.4560.21	Bathroom Lock,	125mm, 150mm	SCP

■ 3/16" (5mm) Sq Spindle

Also available to suit Euro Cylinder
48.4540.10

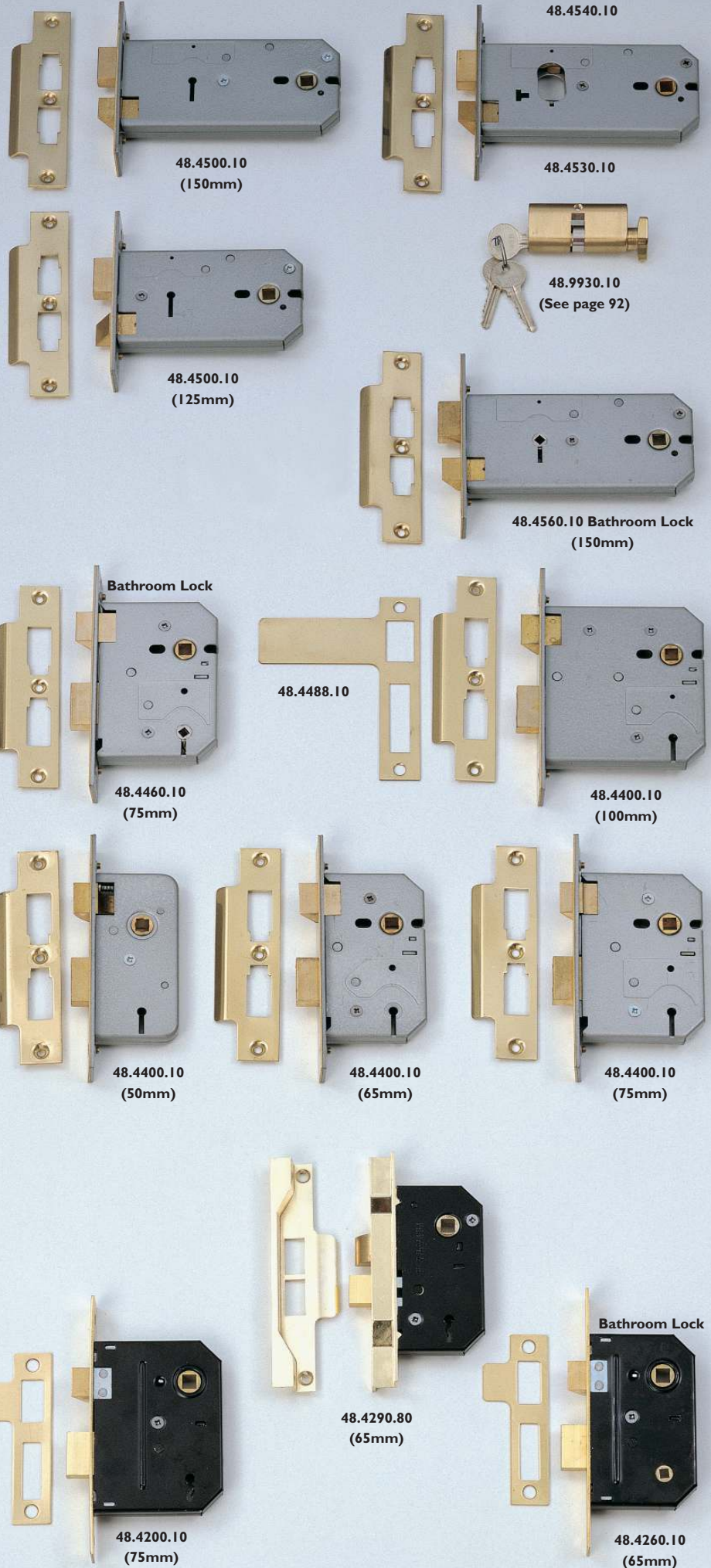

MORTISE LOCKS

All measurements are overall sizes. Rebate sets are required when used on rebated doors. Backset measurement between spindle and door edge.

Overall (mm)	50	65	75	100	125	150
Backset (mm)	32	44	57	82	102	127

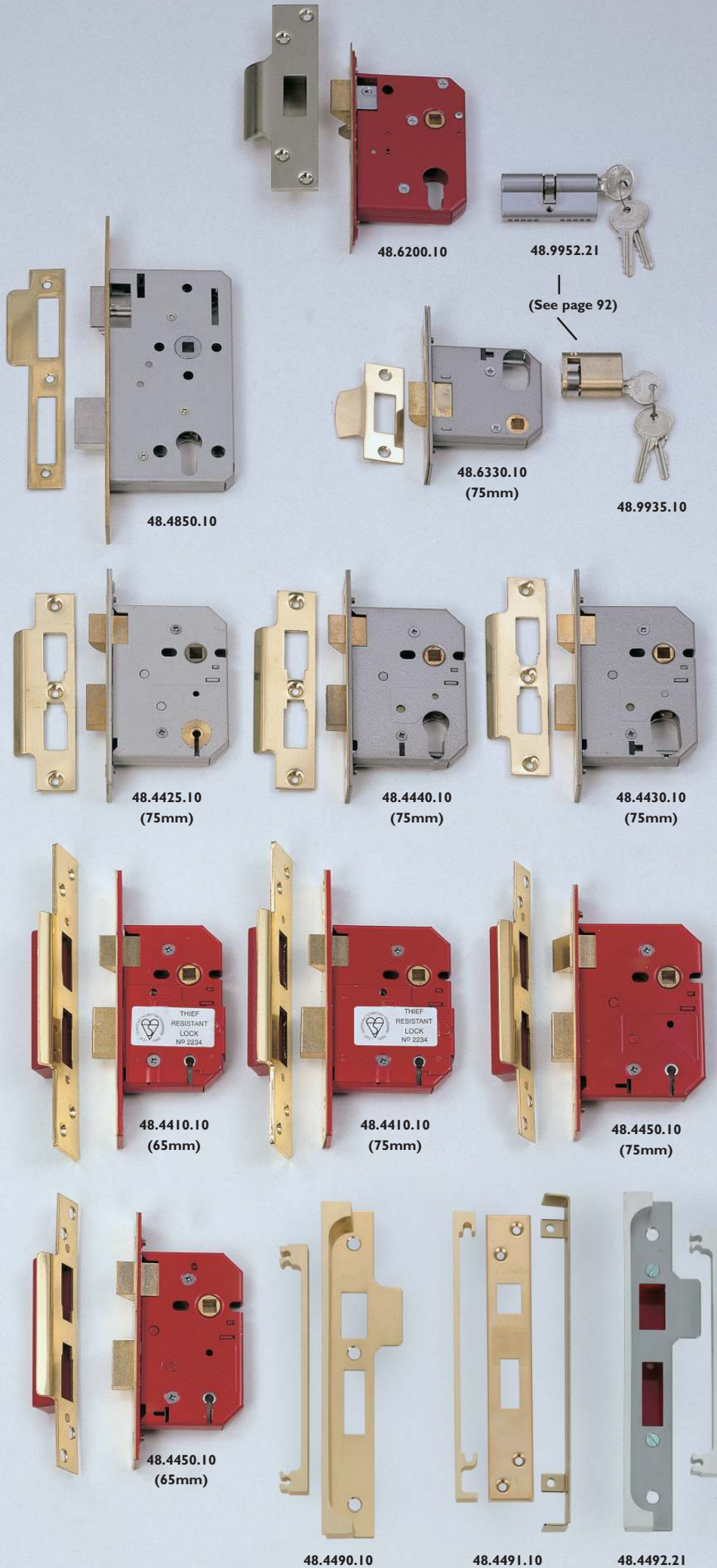

48.4410.10	5L, Kitemark 65mm, 75mm	PB
48.4410.21	(as above)	SCP
48.4425.10	3 Lever, Bushed, 65mm, 75mm	PB
48.4425.21	(as above)	SCP
48.4430.10	Oval Cylinder 65mm, 75mm, 100mm	PB
48.4430.21	(as above)	SCP
48.4440.10	Euro Cylinder, 48 C-T-C 65mm, 75mm	PB
48.4440.21	(as above)	SCP
48.4450.10	5 Lever, 65mm, 75mm	PB
48.4450.21	(as above)	SCP
48.4490.10	Rebate Set for 48.4400 12mm, 20mm, 25mm	PB
48.4490.21	(as above)	SCP
48.4491.10	Rebate Set for 48.4410 12mm, 20mm, 25mm	PB
48.4491.21	(as above)	SCP
48.4492.10	Rebate Set for 48.4450 12mm, 20mm, 25mm	PB
48.4492.21	(as above)	SCP
48.4850.10	European Mortise Lock Euro Cyl, 72mm C-T-C BS=55mm, 85mm	PB
48.4850.20	(as above)	CP
48.6200.10	Euro Night Latch, 48 C-T-C, 75mm	PB
48.6200.21	(as above)	SCP
48.6330.10	Oval Cyl, Night Latch, 65mm, 75mm	PB
48.6330.21	(as above)	SCP

PLEASE ASK FOR INFORMATION ON REBATE SETS AVAILABLE FOR THE ABOVE LOCKS

MORTISE LOCKS

Chubb Mortise Locks.

All measurements are overall sizes. Rebate sets are required when used on rebated doors.

48.3600.10	5 Lever Deadlock	67mm, 80mm	PB
48.3600.21	5 Lever Deadlock	67mm, 80mm	SCP
48.3650.10	5 L, Kitemark, Deadlock	67mm, 80mm	PB
48.3650.21	5 L, Kitemark, Deadlock	67mm, 80mm	SCP
48.3660.10	5 L, Kitemark, Deadlock	54mm	PB
48.3660.21	5 L, Kitemark, Deadlock	54mm	SCP
48.3700.10	5 Detainer, Kitemark, Deadlock, 80mm		PB
48.3700.21	5 Detainer, Kitemark, Deadlock, 80mm		SCP
48.4600.10	5 Lever, Sash Lock	67mm, 80mm	PB
48.4600.21	5 Lever, Sash Lock	67mm, 80mm	SCP
48.4650.10	5L, Kitemark, Sash Lock	67mm, 80mm	PB
48.4650.21	5L, Kitemark, Sash Lock	67mm, 80mm	SCP
48.4700.10	5 Detainer, Sash Lock	75mm	PB
48.4700.21	(as above)		SCP
48.4750.21	5 Detainer, 165mm	BS=150mm	GREY
48.5700.10	5 Detainer, Hook Bolt	70mm	PB
48.6700.10	5 Detainer, Night Latch	80mm	PB
48.6700.21	5 Detainer, Night Latch	80mm	SCP
48.6710.10	Lever Handle	for 48.6700	PB
48.6710.20	(as above)		CP
48.6710.21	(as above)		SCP
48.6715.10	Lever Handle	for 48.6700 LH or RH	PB

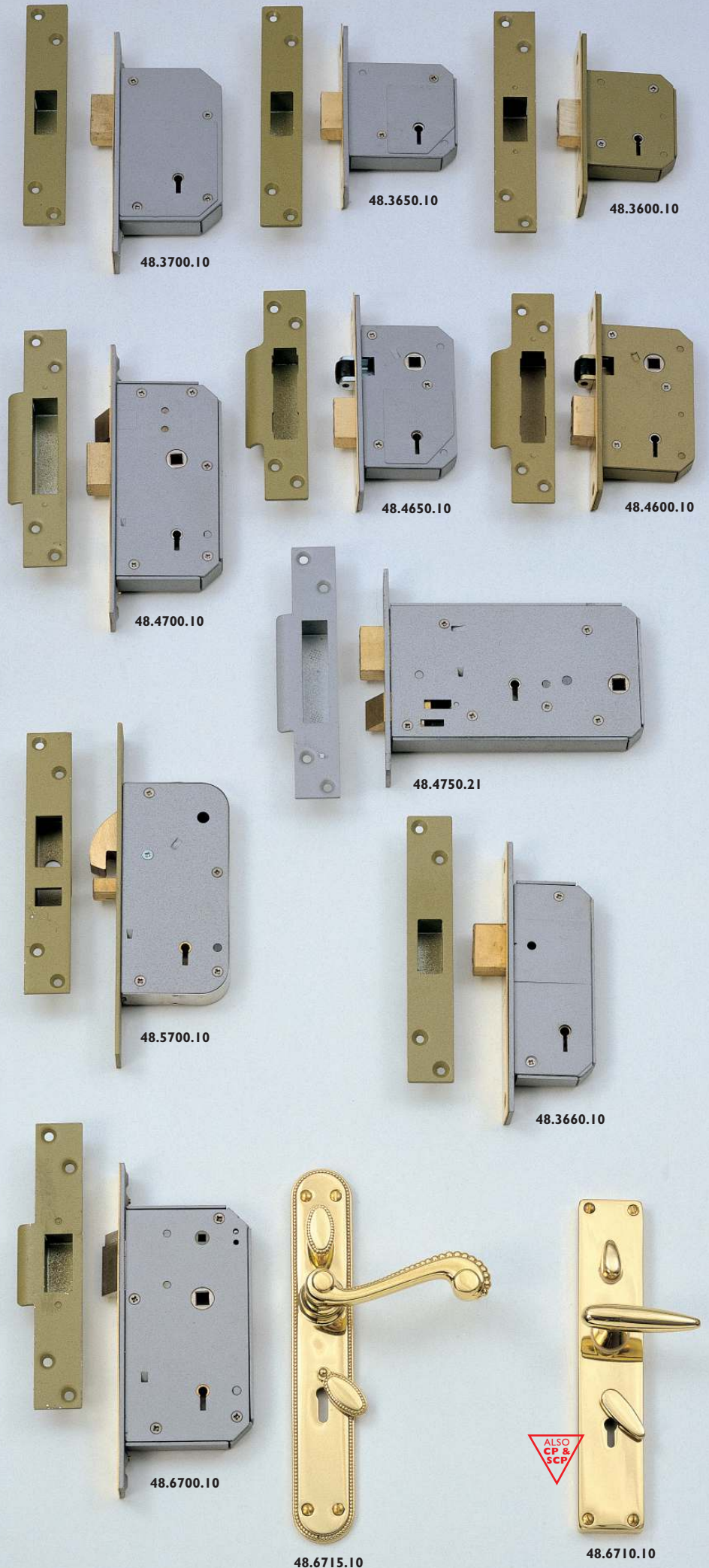

RIM LOCKS

Rim locks and knob furniture are sold separately.

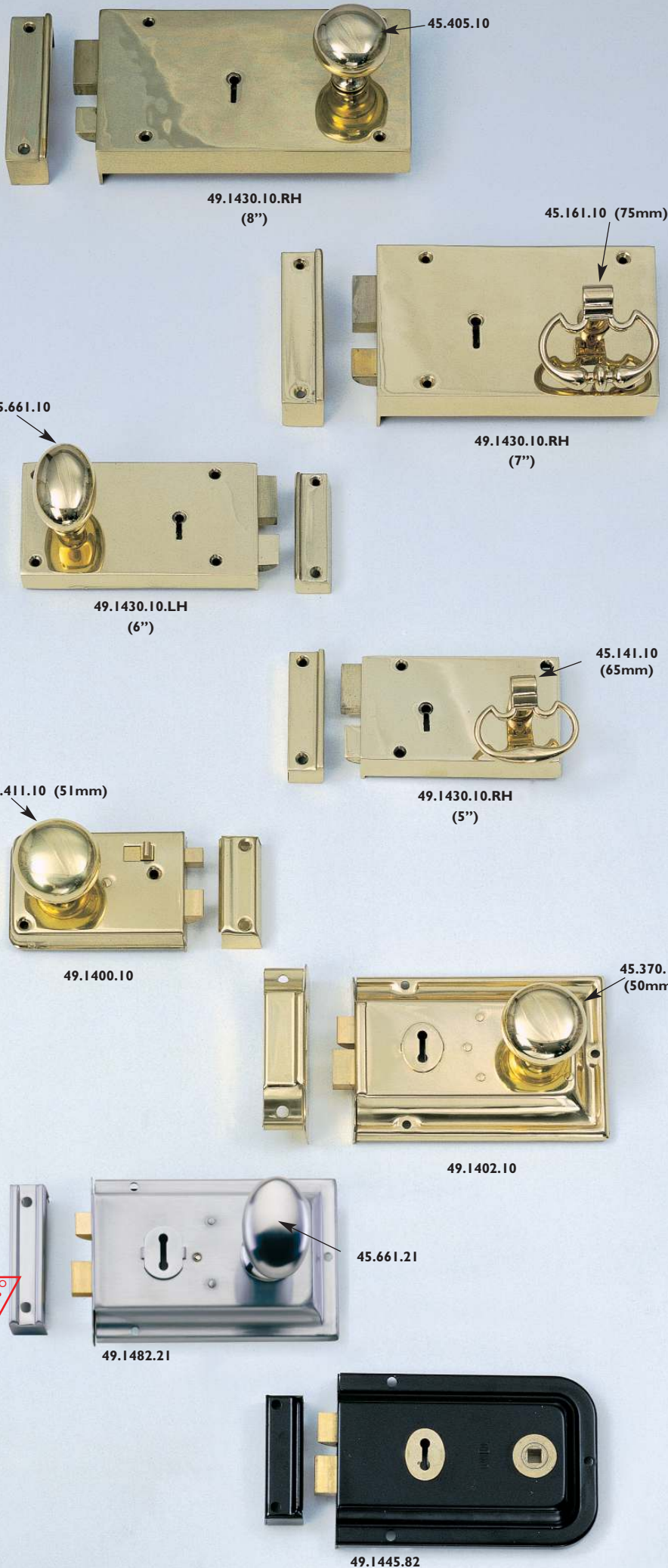

KNOB FURNITURE FOR RIM LOCKS

45.141.10	Ring Furniture	65mm, 75mm	PB
45.161.10	Ring Furniture	65mm, 75mm	PB
45.370.10	50mm, 55mm, Spun		PB
45.405.10	50mm, 57mm, Cast		PB
45.405.20	50mm, 57mm, Cast		CP
45.405.21	50mm, 57mm, Cast		SCP
45.411.10	51mm, 57mm		PB
45.411.20	51mm, 57mm		CP
45.411.21	51mm, 57mm		SCP
45.661.10	57mm, Cast		PB
45.661.20	57mm, Cast		CP
45.661.21	57mm, Cast		SCP

For other Knobs suitable for use with Rim Locks, see pages 83 to 87.

RIM LOCKS

49.1400.10	Brass Rim Latch	102x73mm	PB
49.1402.10	Brass Rim Lock - 2 keys	150x90mm	PB
49.1430.10	Cast Rim Lock LH or RH	5"= 80x127mm	PB
		6"= 80x150mm	PB
		7"= 110x180mm	PB
		8"= 110x207mm	PB
49.1445.82	Steel Rim Lock	152x102mm	BJP
49.1482.20	Brass Rim Lock	152x102mm	CP
49.1482.21	Brass Rim Lock	152x102mm	SCP

ALSO
CP

NIGHT LATCHES

Surface mounted Night Latches for entrance doors.
BS=Backset measurement from key to door edge.

CYLINDER PULLS

16.025.10	Cylinder Pull	PB
16.025.20	Cylinder Pull	CP
16.025.21	Cylinder Pull	SCP
16.030.10	Cylinder Pull	PB
16.035.10	Cylinder Pull	
	for 49.1370 Lock	PB
16.035.20	(as above)	CP
16.035.21	(as above)	SCP
16.065.19	Cylinder Pull for Chubb N/latch	B/LUX
16.090.10	Cylinder Pull	PB

YALE NIGHT LATCHES

49.1001.19	BS=60mm	B/LUX
49.1002.19	BS=40mm	B/LUX
49.1021.19	Kitemark, Deadlocking	
	BS=60mm	B/LUX
49.1021.20	(as above)	CP
★ 49.1022.19	Kitemark, Deadlocking	
	BS=40mm	B/LUX
★ 49.1022.20	(as above)	CP
49.1066.19	Deadlock,	
	BS=60mm	B/LUX
49.1066.70	Deadlock,	
	BS=60mm	GREY
49.1077.19	Standard BS=60mm	B/LUX
49.1077.20	(as above)	CP
49.1077.70	(as above)	GREY
49.1081.70	Roller-Bolt	
	BS=60mm	GREY
49.1085.19	Deadlocking, Narrow	
	BS=40mm	B/LUX
49.1085.20	(as above)	CP
49.1085.70	(as above)	GREY
49.1089.19	Deadlocking,	
	BS=60mm	B/LUX
49.1089.20	(as above)	CP
49.1089.70	(as above)	GREY

REPLACEMENT CYLINDER & 2 KEYS

49.1109.10	PB
49.1109.20	CP
49.1109.21	SCP

★ not illustrated

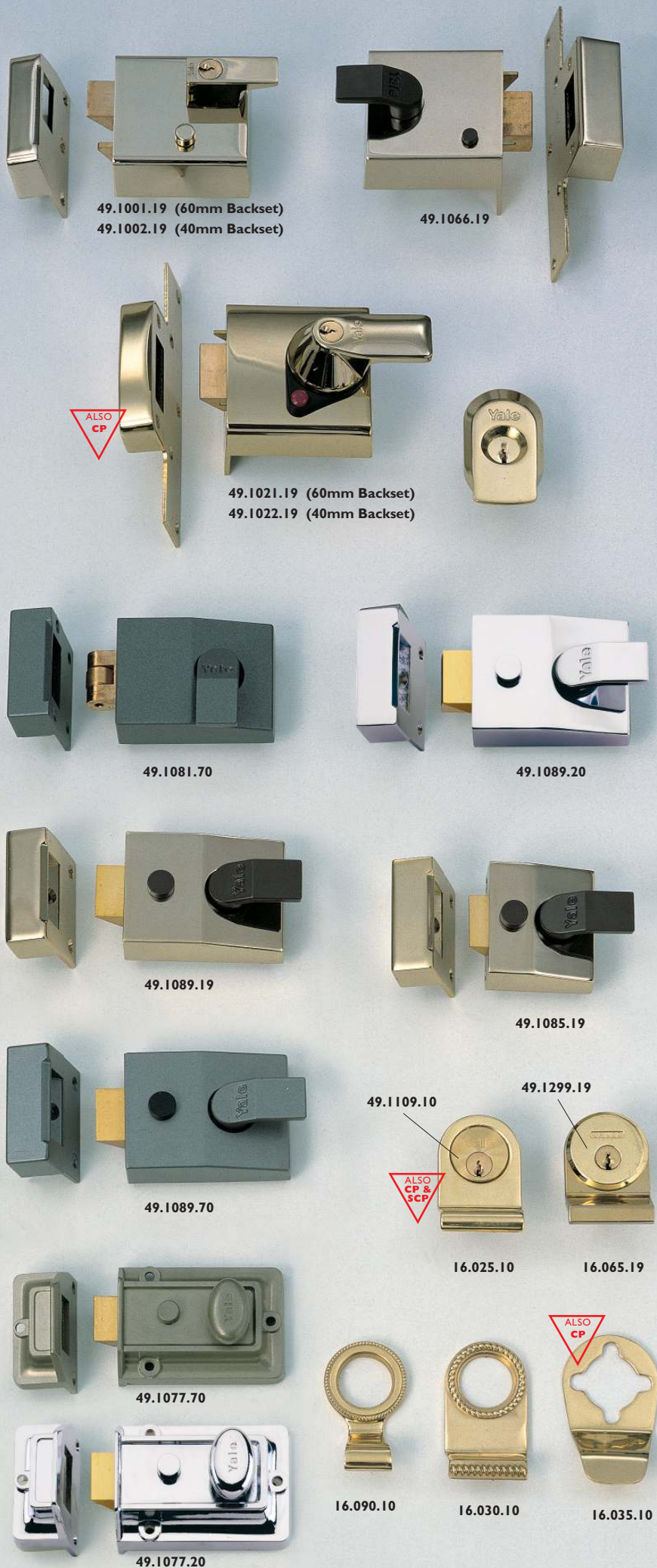

NIGHT LATCHES

Surface mounted Night Latches for entrance doors. BS=Backset measurement from key to door edge.



49.1274.19

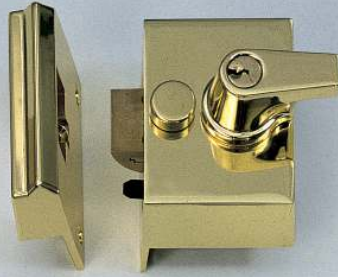

49.1273.19

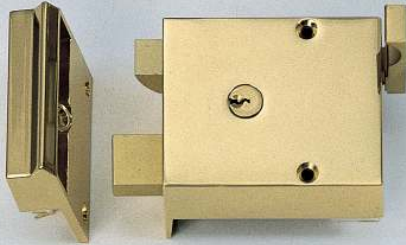

49.1269.19



49.1272.19



49.2230.19



49.9252.70



49.9250.80



49.1922.20



49.1920.21



49.1370.20



49.1370.21



49.1375.10



49.1370.10



49.1371.10

CHUBB NIGHT LATCHES

49.1269.19	Drawback, Double-Throw, BS=60mm	B/LUX
49.1272.19	BS=60mm	B/LUX
49.1273.19	BS=40mm	B/LUX
49.1274.19	BS=60mm	B/LUX
49.1299.19	Replacement Cylinder & 3 Keys	B/LUX

INGERSOLL NIGHT LATCH

49.1370.10	Deadlocking BS=60mm	PB
49.1370.20	(as above)	CP
49.1370.21	(as above)	SCP
49.1371.10	Replacement Cylinder & 3 Keys	PB
49.1371.20	(as above)	CP
49.1371.21	(as above)	SCP
49.1375.10	Outward Opening Keep	PB
49.1375.20	(as above)	CP
49.1375.21	(as above)	SCP

49.1920.19	Deadlocking BS=60mm	B/LUX
49.1920.20	(as above)	CP
49.1920.21	(as above)	SCP
49.1922.19	Deadlocking BS=40mm	B/LUX
49.1922.20	(as above)	CP
49.1922.21	(as above)	SCP

DIGITAL LOCKS

49.2200.19	Deadbolt, Surface	B/LUX
49.2210.19	Mortise Deadbolt	B/LUX
49.2230.19	Mortise Deadlatch	B/LUX
49.2235.19	Mortise N/Latch	B/LUX

ELECTRIC DOOR RELEASES

49.9250.70	Surface 12VoltAC	GREY
49.9250.80	Surface 12VoltAC	EBP
49.9252.70	Mortise 12VoltAC	GREY
49.9252.80	Mortise 12VoltAC	EBP

DECORATIVE METAL GRILLES CATALOGUE

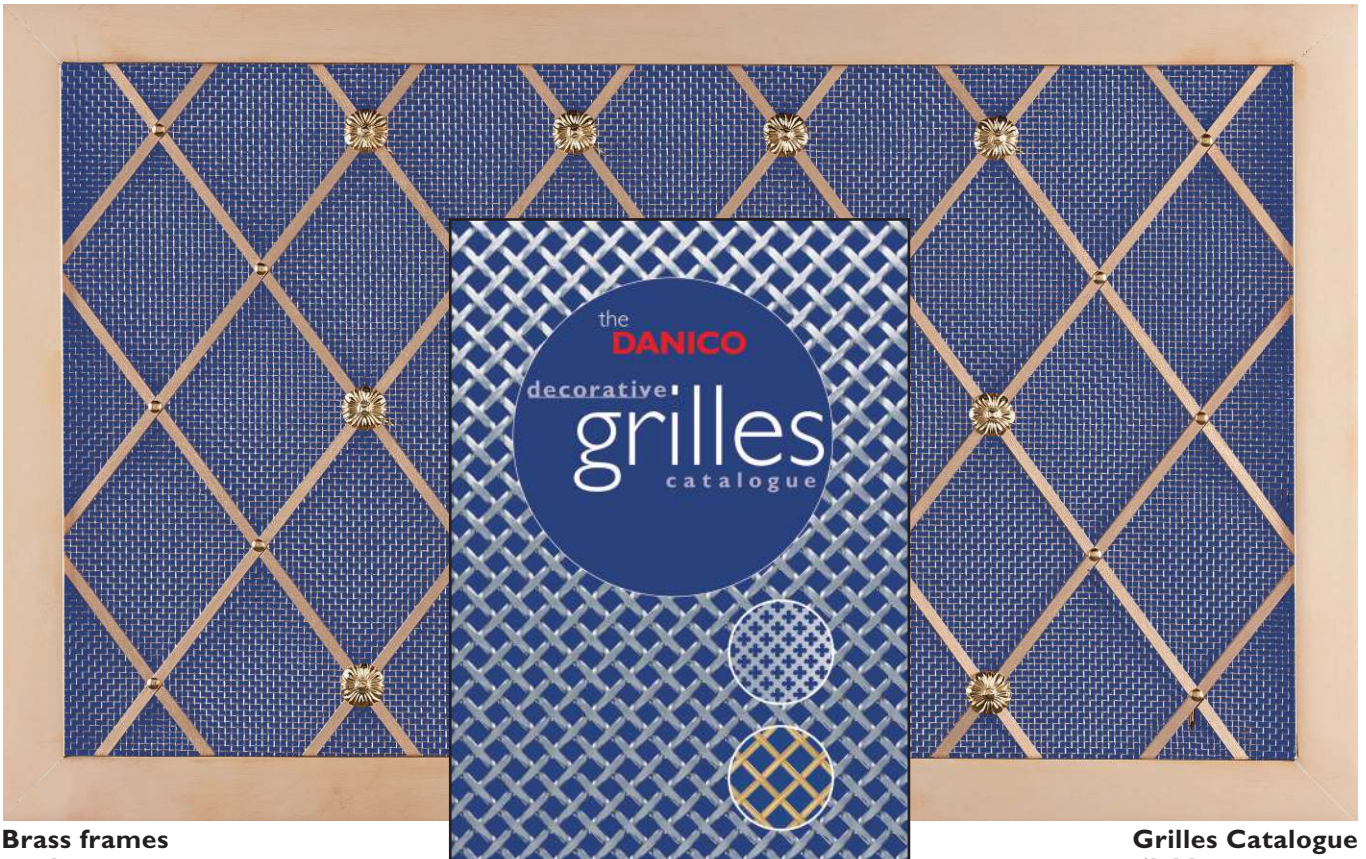

Brass frames
made to measure

Grilles Catalogue
available on request

A SELECTION OF JADO BATHROOM ACCESSORIES & MIXER TAPS



FOR FURTHER INFORMATION OR ADVICE ON DECORATIVE GRILLES,
ELECTRICAL ACCESSORIES, BATHROOM ACCESSORIES AND TAPS,
PLEASE CONTACT OUR SALES OFFICE ON TEL: 020 7483 4477 FAX: 020 7722 7992

DANICO

ARCHITECTURAL IRONMONGERS

*A small selection of our
Electrical Accessories*

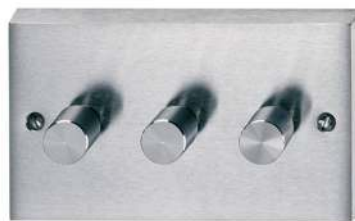
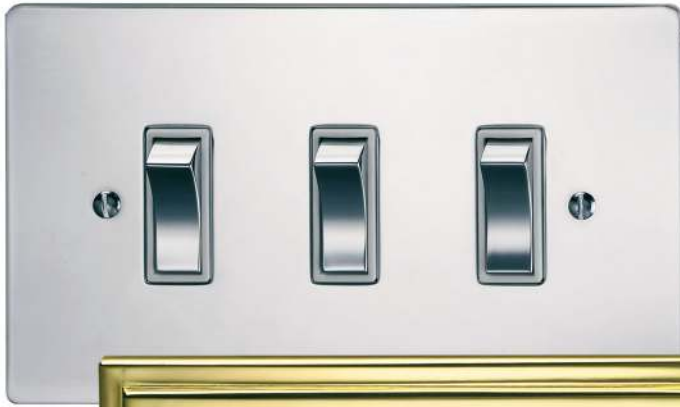

Catalogue available on request